

High Performance Multichannel Audio DAC

Features

- High performance eight-channel DAC
 - Differential analog architecture
 - High-resolution 32-bit digital architecture
 - Low-latency digital filters and digital volume control
- Current-mode output for optimal dynamic range into application-specific output buffer
- PLL supports range of external system-clock references
- Sample timing alignment across multiple devices
- Audio serial port (ASP) sample rates up to 768 kHz
 - I²S, left-justified, and TDM data formats
- DSD interface operating up to 512×fs oversample rate
- Hardware and software control modes
 - I²C control port up to 1 MHz
 - SPI control port up to 24 MHz
 - Hardware control with no host processor required
- Single-supply operation at 3.3 V
 - Support for 1.8 V–3.3 V digital input/outputs
- 48-pin QFN package

Specifications

- Enhanced oversampling sigma-delta DAC
 - 123 dB dynamic range (A-weighted)
 - –115 dB total harmonic distortion + noise (THD+N)
 - 4.5/Fs group delay at 96 kHz sample rate (slow roll-off, minimum-phase filter)
 - 10 mW power consumption per channel (8 channels enabled)

Applications

- A/V receivers
- Digital mixing consoles
- High-performance speakers and soundbars
- DAW interfaces
- Musical instruments

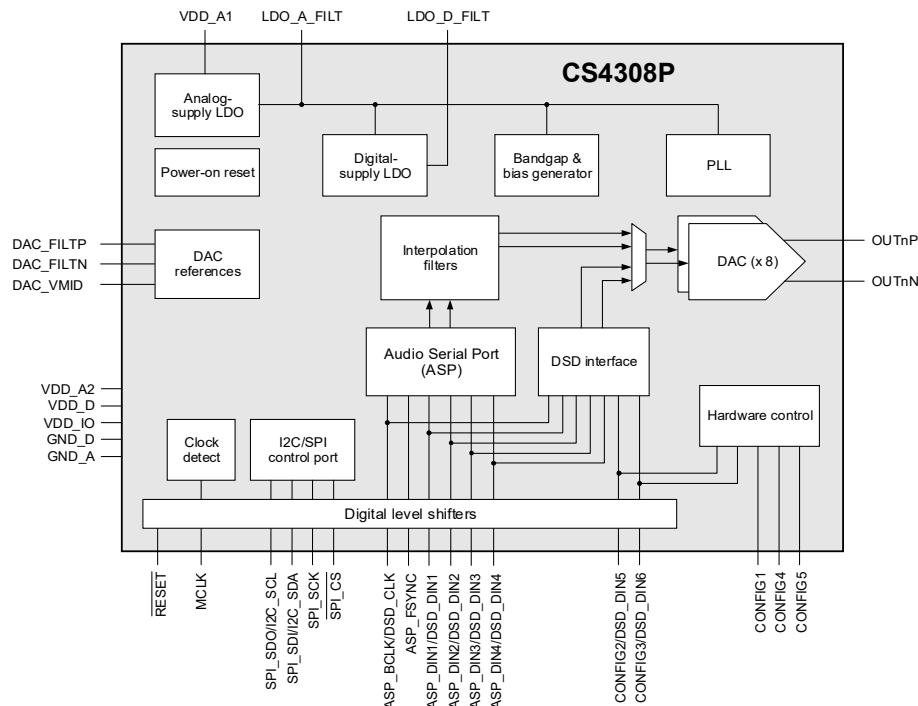

Advanced Product Information

This document contains information for a product under development. Cirrus Logic reserves the right to modify this product without notice.

General Description

The CS4308P is a high-performance, 32-bit resolution, eight-channel DAC. Digital input is supported via the audio serial port (ASP) at sample rates up to 768 kHz. Configurable low-latency digital-interpolation filters are provided. A DSD input path is also available, supporting direct playback modes at up to $512 \times f_s$ oversample rate.

The DAC incorporates a proprietary analog FIR architecture to reduce out-of-band noise and minimize the external component requirements. The differential current-mode output enables a single-stage external op-amp circuit to combine the current-to-voltage conversion and out-of-band filtering, supporting flexible integration and optimal dynamic range for the target application.

The CS4308P can be configured using a control interface supporting I²C and SPI modes of operation. The device can also be operated in hardware mode, using external resistors to select the required configuration. Multiple hardware-control options are supported, including system clocking, ASP format, sample rate, and digital-filter selection.

The low-latency digital filters are optimized for the applicable sample rate. Fast or slow roll-off filters can be combined with minimum or linear phase responses to support the desired signal characteristics. A de-emphasis filter is also available.

The ASP supports multichannel operation in I²S, left-justified, and TDM data formats. Four data-input pins support 32-bit multichannel operation up to 384 kHz (eight channels) or 768 kHz (four channels).

The Direct Stream Digital (DSD) input path supports six-channel operation at oversample rates up to $512 \times f_s$.

Clocking for the CS4308P can be derived from the ASP or DSD interface, or else provided from a separate clock source. An integrated phase-locked loop (PLL) is used to reduce jitter and to support a range of reference-clock frequency options. The DAC-conversion timing is referenced to the ASP data frame, enabling time-aligned operation across multiple devices sharing a common data bus.

The CS4308P can be powered from a single 3.3 V supply; an integrated regulator provides the 1.2 V digital-core supply. Digital input/output at 1.8 V logic levels is also possible using a separate external supply. The device combines high performance with low power consumption.

The CS4308P is available in a commercial-grade 0.4 mm pitch, 48-pin QFN package for operation from -40° to $+85^\circ\text{C}$.

See [Section 11](#) for ordering information.

Table of Contents

1 Pin Assignments and Descriptions	4
1.1 48-Pin QFN (Top View, Through-Package)	4
1.2 QFN Pin Descriptions	4
1.3 Termination of Unused Pins	6
1.4 Electrostatic Discharge (ESD) Protection	6
2 Typical Connection Diagram	7
3 Characteristics and Specifications	8
Table 3-1. Parameter Definitions	8
Table 3-2. Recommended Operating Conditions	8
Table 3-3. Absolute Maximum Ratings	8
Table 3-4. DAC Path Characteristics	9
Table 3-5. DAC Filter Characteristics	9
Table 3-6. DAC High-Pass Filter (HPF)	10
Table 3-7. Device Power Consumption	11
Table 3-8. Digital Interface Specifications and Characteristics	11
Table 3-9. DC Characteristics	11
Table 3-10. Switching Specifications—Reset and Clock References	12
Table 3-11. Switching Specifications—Audio Serial Port (ASP)	13
Table 3-12. Switching Specifications—Direct Stream Digital (DSD) Interface	14
Table 3-13. Switching Specifications—I ² C Control Port	15
Table 3-14. Switching Specifications—SPI Control Port	16
4 Functional Description	17
4.1 Device Power and Reset	17
4.2 Hardware Configuration	17
4.3 Software Configuration	19
4.4 System Clocking	19
4.5 DAC and Analog Output	23
4.6 Digital Filter Selection	25
4.7 Audio Serial Port (ASP)	27
4.8 DSD Interface	38
4.9 I ² C/SPI Control Port	40
4.10 General-Purpose Output	44
4.11 Device ID	44
5 Register Quick Reference	45
5.1 DEVID	45
5.2 CONFIG	45
5.3 OUTPUT_PATH	46
5.4 PIN_CONFIG	47
6 Register Descriptions	48
6.1 DEVID	48
6.2 CONFIG	49
6.3 OUTPUT_PATH	51
6.4 PIN_CONFIG	57
7 Performance Plots	59
7.1 DAC Filter Response	59
8 Thermal Characteristics	72
9 Package Dimensions	72
10 Package Marking	73
11 Ordering Information	73
12 References	73
13 Revision History	73

1 Pin Assignments and Descriptions

1.1 48-Pin QFN (Top View, Through-Package)

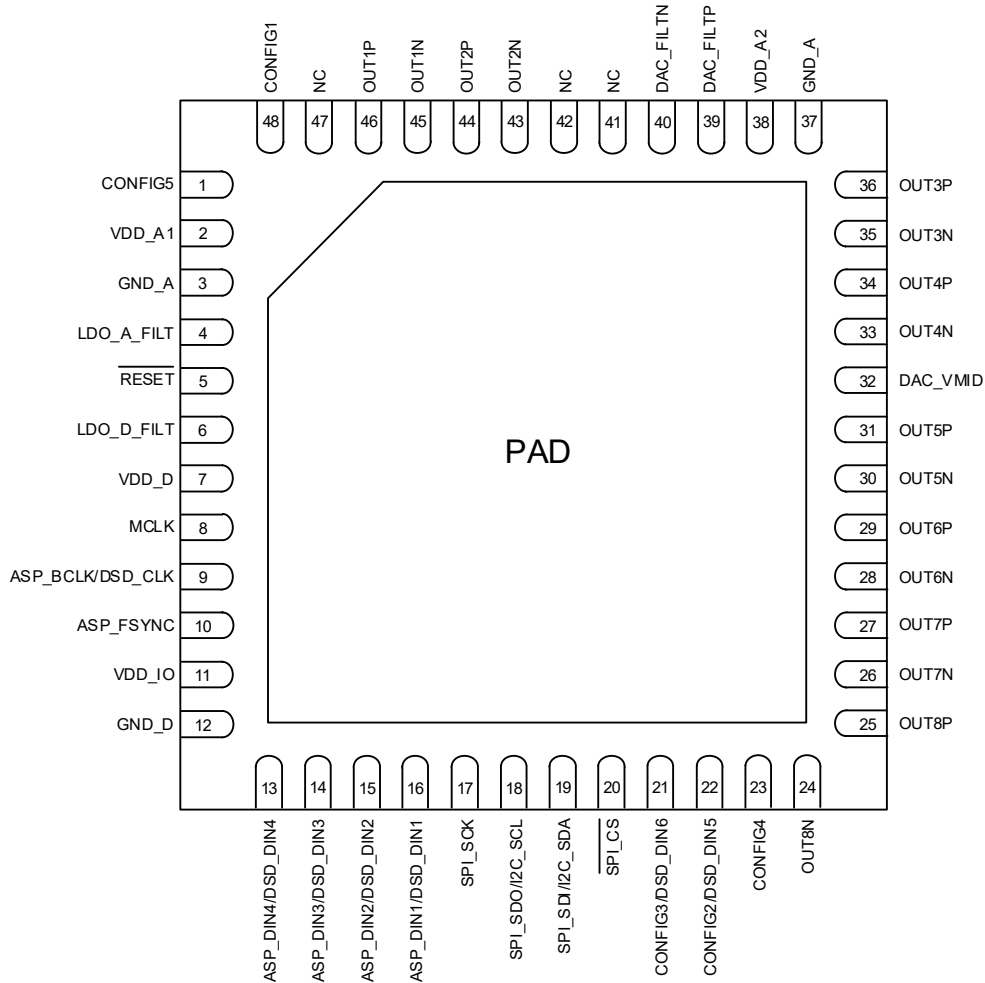

Figure 1-1. QFN 48-pin diagram (Top View, Through Package)

1.2 QFN Pin Descriptions

Table 1-1. QFN Pin Descriptions

Pin Name	Pin #	Power Supply	I/O	Description
Digital I/O				
ASP_BCLK/DSD_CLK	9	VDD_IO	I/O	Audio serial port bit clock/DSD clock.
ASP_DIN1/DSD_DIN1	16	VDD_IO	O	Audio serial port data input/DSD data input.
ASP_DIN2/DSD_DIN2	15			
ASP_DIN3/DSD_DIN3	14			
ASP_DIN4/DSD_DIN4	13			
ASP_FSYNC	10	VDD_IO	I/O	Audio serial port frame sync.
MCLK	8	VDD_IO	I	Master clock input.
RESET	5	VDD_IO	I	Hardware reset control (active low).
SPI_CS	20	VDD_IO	I	SPI chip select (active low).

Table 1-1. QFN Pin Descriptions (Cont.)

Pin Name	Pin #	Power Supply	I/O	Description
SPI_SCK	17	VDD_IO	I	SPI clock.
SPI_SDI/I2C_SDA	19	VDD_IO	I/O	SPI data input/I2C data input/output.
SPI_SDO/I2C_SCL	18	VDD_IO	I/O	SPI data output/I2C clock input.
Analog I/O				
CONFIG1	48	VDD_A	I/O	Hardware control pins.
CONFIG2/DSD_DIN5	22	VDD_IO		In software control mode, CONFIG2–3 support the Direct Stream Digital (DSD) interface.
CONFIG3/DSD_DIN6	21	VDD_IO		
CONFIG4	23	VDD_IO		In software control mode, CONFIG5 selects the I2C target address.
CONFIG5	1	VDD_A		
DAC_FILT_N	40	VDD_A	O	DAC external capacitor connection.
DAC_FILT_P	39			The DAC_FILT_P capacitor should be connected to VDD_A2.
DAC_VMID	32	VDD_A	O	DAC mid-rail voltage reference output.
LDO_A_FILT	4	VDD_A	O	LDO_A regulator external capacitor connection.
LDO_D_FILT	6	VDD_A	O	LDO_D regulator external capacitor connection.
OUT1N	45	VDD_A	O	Analog Output 1.
OUT1P	46			
OUT2N	43	VDD_A	O	Analog Output 2.
OUT2P	44			
OUT3N	35	VDD_A	O	Analog Output 3.
OUT3P	36			
OUT4N	33	VDD_A	O	Analog Output 4.
OUT4P	34			
OUT5N	30	VDD_A	O	Analog Output 5.
OUT5P	31			
OUT6N	28	VDD_A	O	Analog Output 6.
OUT6P	29			
OUT7N	26	VDD_A	O	Analog Output 7.
OUT7P	27			
OUT8N	24	VDD_A	O	Analog Output 8.
OUT8P	25			
Power Supplies				
VDD_D	7	—	—	Digital supply (powered from internal LDO)
VDD_A1	2	—	—	Analog supply
VDD_A2	38	—	—	Analog supply
VDD_IO	11	—	—	Digital I/O supply
GND_D	12	—	—	Digital ground 1
GND_A	3, 37, PAD	—	—	Analog ground 1
No Connect				
NC	41, 42, 47	—	—	No connect

1. All ground pins, including the ground paddle, must be tied to a common ground plane directly underneath the CS4308P.

1.3 Termination of Unused Pins

Table 1-2 shows the required termination for unused pins (i.e., if the functionality of the pin is not being used). Pins not listed must be connected as shown in the typical connection drawings (see Section 2).

Table 1-2. Termination of Unused Pins

Name	Termination if unused
OUT _n x	Float
RESET	
ASP_DIN _x	Grounded
CONFIG _x	
MCLK	
SPI_SDO/I2C_SCL	
SPI_SCK	
SPI_SDI/I2C_SDA	
SPI_CS	Connect to VDD_IO

1.4 Electrostatic Discharge (ESD) Protection



ESD-sensitive device. The CS4308P is manufactured on a CMOS process. Therefore, it is generically susceptible to damage from excessive static voltages. Proper ESD precautions must be taken while handling and storing this device. This device is qualified to current JEDEC ESD protection standards.

2 Typical Connection Diagram

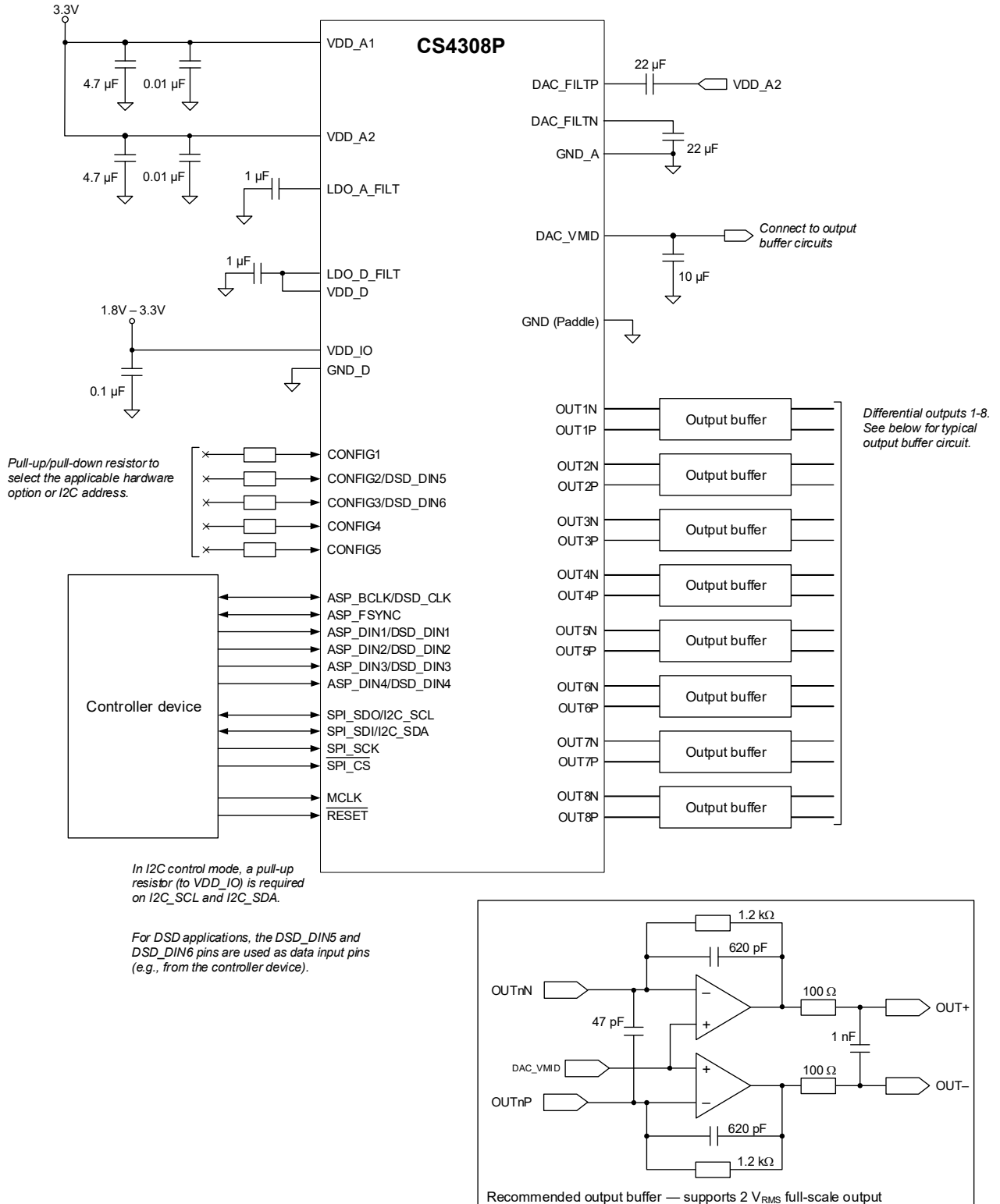

Figure 2-1. Typical Connections

3 Characteristics and Specifications

Note: Table 3-1 defines parameters as they are characterized in this section. Note that default register field configurations are used unless specified otherwise in the test conditions.

Table 3-1. Parameter Definitions

Parameter	Definition
Channel separation	The difference in level between the active channel (driven to maximum full scale output) and the measured signal level in the idle channel at the test signal frequency. The active channel is configured and supplied with an appropriate input signal to drive a full scale output, with signal measured at the output of the associated idle channel.
Common-mode rejection ratio (CMRR)	The ratio of a specified input signal (applied to both sides of a differential input), relative to the output signal that results from it.
Dynamic range	The difference in level between the maximum full scale output signal and the sum of all harmonic distortion products plus noise with a low-level input signal applied. Typically, an input signal level 60 dB below full scale is used.
Power-supply rejection ratio (PSRR)	The ratio of a specified power supply variation relative to the output signal that results from it. PSRR is measured under quiescent signal path conditions.
Total harmonic distortion plus noise (THD+N)	The ratio of the RMS sum of the harmonic distortion products plus noise in the specified bandwidth relative to the RMS amplitude of the fundamental (i.e., test frequency) output.

Note: Unless specified otherwise, all performance measurements are for a 10 Hz to 20 kHz bandwidth.

Table 3-2. Recommended Operating Conditions

Test conditions (unless specified otherwise): Ground = GND = GND_A = GND_D = 0 V; voltages are with respect to ground.

Parameter		Symbol	Minimum	Maximum	Unit
DC power supply	Analog supply ¹	VDDA1, VDDA2	3.13	3.47	V
	Digital supply (powered from internal LDO) ²	VDD_D	1.14	1.26	V
	Digital I/O supply	VDD_IO	1.71	3.63	V
Supply ramp up/down (all supplies)		t _{PWR-UD}	0.01	10	ms
Ambient temperature		T _A	-40	+85	°C

Note: The device is fully functional and meets all parametric specifications in this section if operated within the specified conditions. Functionality and parametric performance is not guaranteed or implied outside of these limits. Operation outside of these limits may adversely affect device reliability.

- The VDD_A1 and VDD_A2 rails should be tied together and powered from a single supply. The associated power domain is referred to as VDD_A.
- The digital supply is powered from an internal LDO regulator. The VDD_D pin must be connected to the LDO output pin, LDO_D_FILTER.

Table 3-3. Absolute Maximum Ratings

Test conditions (unless specified otherwise): Ground = GND = GND_A = GND_D = 0 V; voltages are with respect to ground.

Parameter		Symbol	Minimum	Maximum	Unit
DC power supply	Analog supply ¹	VDDA1, VDDA2	-0.3	4.32	V
	Digital supply	VDD_D	-0.3	1.52	V
	Digital I/O supply	VDD_IO	-0.3	4.32	V
External voltage applied to digital input/output		V _{INDI}	-0.3	VDD_IO + 0.3	V
External voltage applied to analog inputs		CONFIG2, CONFIG3, CONFIG4	-0.3	VDD_IO + 0.3	V
		All other analog inputs	-0.3	VDD_A + 0.3	V
Input current	digital input/output	I _{in}	—	±10	mA
	analog inputs		—	±10	mA
Ambient operating temperature		T _A	-40	+115	°C
Junction operating temperature		T _J	-40	+125	°C
Storage temperature		T _{STG}	-65	+150	°C

Caution: Stresses beyond “Absolute Maximum Ratings” levels may cause permanent damage to the device. These levels are stress ratings only, and functional operation of the device at these or any other conditions beyond those indicated in Table 3-2 is not implied. Exposure to absolute maximum rating conditions for extended periods may affect device reliability.

- The VDD_A1 and VDD_A2 rails should be tied together and powered from a single supply. The associated power domain is referred to as VDD_A.

Table 3-4. DAC Path Characteristics

Test conditions (unless specified otherwise): External components as shown in Fig. 2-1; VDD_A = VDD_IO = 3.3 V; VDD_D = 1.2 V (powered from internal LDO); Ground = GND_A = GND_D = 0 V; voltages are with respect to ground; T_A = +25°C; 1 kHz sine wave test signal; F_s = 48 kHz, 32-bit audio data, MCLK = 24.576 MHz; measured with output connected to a 1.2 kΩ transimpedance amplifier as shown in Fig. 2-1.

Parameter		Min	Typ	Max	Units
Full scale output	0 dBFS input	—	1.67	—	mA _{RMS}
Dynamic range	A-weighted	120	123	—	dB
	unweighted	117	120	—	dB
THD+N	0 dBFS input	—	−115	TBD	dB
	−20 dBFS input	—	−97	—	dB
	−60 dBFS input	—	−57	—	dB
Idle channel noise	A-weighted	—	1.15	—	nA _{RMS} nA _R MS
Channel separation	1 kHz	—	110	—	dB
	20 kHz	—	100	—	dB
PSRR (VDD_A)	100 mV (peak-peak) 1 kHz sine wave	—	75	—	dB

Table 3-5. DAC Filter Characteristics

Test conditions (unless specified otherwise): VDD_A = VDD_IO = 3.3 V; VDD_D = 1.2 V (powered from internal LDO); Ground = GND_A = GND_D = 0 V; voltages are with respect to ground; T_A = +25°C; 1 kHz sine wave test signal; F_s = 48 kHz, 32-bit audio data.

Parameter ¹		Min	Typ	Max	Units		
F _s = 32 kHz	Fast roll-off	Passband	to −3 dB corner	—	—	0.49	F _s
		Passband ripple	f ≤ 0.45 F _s	−0.001	—	0.001	dB
		Stopband attenuation	f ≥ 0.55 F _s	100	—	—	dB
		Group delay ²	linear phase	—	32.5/F _s	—	—
minimum phase	—		4.6/F _s	—	—	s	
F _s = 44.1 or 48 kHz	Fast roll-off	Passband	to −3 dB corner	—	—	0.49	F _s
		Passband ripple	f ≤ 0.45 F _s	−0.001	—	0.001	dB
		Stopband attenuation	f ≥ 0.55 F _s	100	—	—	dB
		Group delay ²	linear phase	—	32.6/F _s	—	—
	minimum phase		—	4.7/F _s	—	—	s
	Slow roll-off	Passband	to −3 dB corner	—	—	0.47	F _s
		Passband ripple	f ≤ 0.42 F _s	−0.004	—	0.005	dB
		Stopband attenuation	f ≥ 0.59 F _s	101	—	—	dB
		Group delay ²	linear phase	—	17.1/F _s	—	—
	minimum phase		—	4.6/F _s	—	—	s
F _s = 88.2 or 96 kHz	Fast roll-off	Passband	to −3 dB corner	—	—	0.49	F _s
		Passband ripple	f ≤ 0.45 F _s	−0.001	—	0.001	dB
		Stopband attenuation	f ≥ 0.55 F _s	101	—	—	dB
		Group delay ²	linear phase	—	32.9/F _s	—	—
	minimum phase		—	5.0/F _s	—	—	s
	Slow roll-off	Passband	to −3 dB corner	—	—	0.39	F _s
		Passband ripple	f ≤ 0.23 F _s	−0.005	—	0.005	dB
		Stopband attenuation	f ≥ 0.70 F _s	90	—	—	dB
		Group delay ²	linear phase	—	7.4/F _s	—	—
	minimum phase		—	4.5/F _s	—	—	s
	Balanced roll-off	Passband	to −3 dB corner	—	—	0.35	F _s
		Passband ripple	f ≤ 0.23 F _s	−0.001	—	0.001	dB
Stopband attenuation		f ≥ 0.55 F _s	101	—	—	dB	
Group delay ²		linear phase	—	11.6/F _s	—	—	s
	minimum phase	—	5.2/F _s	—	—	s	

Table 3-5. DAC Filter Characteristics (Cont.)

Test conditions (unless specified otherwise): VDD_A = VDD_IO = 3.3 V; VDD_D = 1.2 V (powered from internal LDO); Ground = GND_A = GND_D = 0 V; voltages are with respect to ground; T_A = +25°C; 1 kHz sine wave test signal; F_s = 48 kHz, 32-bit audio data.

Parameter ¹		Min	Typ	Max	Units	
F _s = 176.4 or 192 kHz	Fast roll-off	Passband to -3 dB corner	—	—	0.48	F _s
		Passband ripple f ≤ 0.45 F _s	-0.004	—	0.005	dB
		Stopband attenuation f ≥ 0.55 F _s	103	—	—	dB
		Group delay ²	—	35.1/F _s 6.6/F _s	—	s s
	Slow roll-off	Passband to -3 dB corner	—	—	0.36	F _s
		Passband ripple f ≤ 0.11 F _s	-0.001	—	0.001	dB
		Stopband attenuation f ≥ 0.80 F _s	108	—	—	dB
		Group delay ²	—	7.6/F _s 5.4/F _s	—	s s
	Balanced roll-off	Passband to -3 dB corner	—	—	0.28	F _s
		Passband ripple f ≤ 0.11 F _s	-0.001	—	0.001	dB
		Stopband attenuation f ≥ 0.55 F _s	110	—	—	dB
		Group delay ²	—	10.6/F _s 6.7/F _s	—	s s
F _s = 352.8 or 384 kHz	Fast roll-off	Passband to -3 dB corner	—	—	0.30	F _s
		Passband ripple f ≤ 0.23 F _s	-0.004	—	0.000	dB
		Stopband attenuation f ≥ 0.55 F _s	116	—	—	dB
		Group delay ²	—	14.4/F _s 7.7/F _s	—	s s
	Balanced roll-off	Passband to -3 dB corner	—	—	0.23	F _s
		Passband ripple f ≤ 0.06 F _s	-0.001	—	0.000	dB
		Stopband attenuation f ≥ 0.55 F _s	116	—	—	dB
		Group delay ²	—	10.4/F _s 7.6/F _s	—	s s
F _s = 705.6 or 768 kHz	Fast roll-off	Passband to -3 dB corner	—	—	0.15	F _s
		Passband ripple f ≤ 0.11 F _s	-0.005	—	0.001	dB
		Stopband attenuation f ≥ 0.30 F _s	101	—	—	dB
		Group delay ²	—	23.9/F _s 13.7/F _s	—	s s
	Balanced roll-off	Passband to -3 dB corner	—	—	0.12	F _s
		Passband ripple f ≤ 0.03 F _s	-0.001	—	0.000	dB
		Stopband attenuation f ≥ 0.27 F _s	116	—	—	dB
		Group delay ²	—	19.9/F _s 14.3/F _s	—	s s

1. The DAC filters are supported on the ASP path only; they are not supported for the DSD input path.

2. Group delay is measured from the start of the FSYNC frame containing the audio data on the ASP_DINn pin to the time at which the signal is presented on the output pins (OUTnP/OUTnN).

Table 3-6. DAC High-Pass Filter (HPF)

Test conditions (unless specified otherwise): VDD_A = VDD_IO = 3.3 V; VDD_D = 1.2 V (powered from internal LDO); Ground = GND_A = GND_D = 0 V; voltages are with respect to ground; T_A = +25°C; 1 kHz sine wave test signal; F_s = 48 kHz, 32-bit audio data.

Parameter ¹	Min	Typ	Max	Units
Passband	—	19	—	Hz
	—	1	—	Hz
Phase deviation	—	0.001	—	degree
Filter settling time	—	0.4	—	s

1. The DAC high-pass filter is supported on the ASP path only; it is not supported for the DSD input path.

Table 3-7. Device Power Consumption

Test conditions (unless specified otherwise): VDD_A = VDD_IO = 3.3 V; VDD_D = 1.2 V (powered from internal LDO); Ground = GND = GND_A = GND_D = 0 V; voltages are with respect to ground; T_A = +25°C; 1 kHz sine wave test signal; F_s = 48 kHz, 32-bit audio data.

Use Configuration		Typical Current (mA)		Total Power (mW)
		I _{VDD_A}	I _{VDD_IO}	
Reset	RESET = Logic 0	0.70	0.04	2.4
Eight channels enabled		TBD	TBD	TBD

Table 3-8. Digital Interface Specifications and Characteristics

Test conditions (unless specified otherwise): Ground = GND = GND_A = GND_D = 0 V; voltages are with respect to ground; T_A = +25°C.

Parameter	Symbol	Minimum	Maximum	Unit
Input leakage current (per pin)	I _{IN}	—	±10	μA
Input capacitance (per pin)	—	—	5	pF
Digital I/O (VDD_IO logic—all pins except CONFIG1 and CONFIG5) 1	High-level output	V _{OH}	0.9×VDD_IO	—
	Low-level output	V _{OL}	—	0.1×VDD_IO
	High-level input	V _{IH}	0.7×VDD_IO	—
	Low-level input	V _{IL}	—	0.3×VDD_IO
Digital I/O (VDD_A logic—CONFIG1 and CONFIG5 pins) 1	High-level output	V _{OH}	0.9×VDD_A	—
	Low-level output	V _{OL}	—	0.1×VDD_A

1. The CONFIGx pins support digital output if configured as GP output (see Section 4.10).

Table 3-9. DC Characteristics

Test conditions (unless specified otherwise): VDD_A = VDD_IO = 3.3 V; VDD_D = 1.2 V (powered from internal LDO); Ground = GND = GND_A = GND_D = 0 V; voltages are with respect to ground; T_A = +25°C.

Parameter	Minimum	Typical	Maximum	Unit
DAC_FILT 1	Nominal voltage	2.00	—	V
		1.25	—	V
	Maximum output current	—	50	μA
DAC_VMID 2	Nominal voltage	1.65	—	V
	Maximum output current	—	0.01	mA
VDD_A power-on reset (POR) threshold (V _{POR})	VDD_A rising	1.9	—	V
	VDD_A falling	1.8	—	V
VDD_D power-on reset (POR) threshold (V _{POR})	VDD_D rising	0.90	—	V
	VDD_D falling	0.75	—	V

- DAC_FILT characteristics are provided as a guide for external component selection. The output current (arising from capacitor leakage) must be less than the maximum output current of the DAC_FILT pin.
- The output current (arising from capacitor leakage and the input-buffer circuit) must be less than the maximum output current of the DAC_VMID pin. If a larger current is required, an external VMID buffer should be used. A buffer can be provided using a standard op-amp (noise voltage < 5 nV/√Hz, input current < 10 μA). An example circuit is as follows:

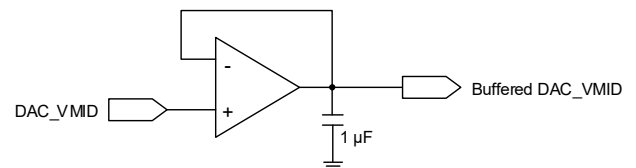

Table 3-10. Switching Specifications—Reset and Clock References

Test conditions (unless specified otherwise): VDD_A = VDD_IO = 3.3 V; VDD_D = 1.2 V (powered from internal LDO); Ground = GND = GND_A = GND_D = 0 V; voltages are with respect to ground; T_A = +25°C.

Parameter		Symbol	Minimum	Typical	Maximum	Unit
Reset	RESET low (logic 0) pulse width	t _{RLPW}	1	—	—	ms
	RESET rising edge to control port active	t _{IRS}	—	—	5	ms
MCLK input	MCLK frequency (MCLK as clock source, PLL not used)	f _{MCLK}	—	45.1584 49.152	—	MHz MHz
	MCLK duty cycle (MCLK as clock source, PLL not used)	D _{MCLK}	40	—	60	%
	MCLK frequency tolerance (MCLK as clock source, PLL not used)	—	-1	—	1	%
Phase-locked loop (PLL)	REFCLK input frequency (BCLK or MCLK reference) ¹	f _{REFCLK}	—	2.8224	—	MHz
			—	5.6448	—	MHz
			—	11.2896	—	MHz
			—	22.5792	—	MHz
			—	3.072	—	MHz
			—	6.144	—	MHz
			—	12.288	—	MHz
	—	24.576	—	MHz		
	REFCLK input duty cycle	D _{REFCLK}	45	—	55	%
	REFCLK frequency tolerance	—	-1	—	1	%
PLL output frequency	Fs = 32, 48, 96, 192, 384, 768 kHz Fs = 44.1, 88.2, 176.4, 352.8, 705.6 kHz	f _{PLL_OUT}	—	49.152	—	MHz
			—	45.1584	—	MHz
PLL output jitter		j _{PLL_OUT}	—	500	—	pSRMS
PLL output period jitter		j _{PLL_OUT-PER}	—	—	500	ps
PLL lock time		t _{PLL_LOCK}	—	0.3	1	ms

1. Note the REFCLK input frequency must be integer-related to the sample rate. See [Section 4.4](#) for further details.

Table 3-11. Switching Specifications—Audio Serial Port (ASP)

Test conditions (unless specified otherwise): VDD_A = 3.3 V; VDD_D = 1.2 V (powered from internal LDO); Ground = GND = GND_A = GND_D = 0 V; voltages are with respect to ground; input timings are measured at V_{IL} and V_{IH} thresholds, output timings are measured at V_{OL} and V_{OH} thresholds for VDD_IO logic (as specified in Table 3-8); T_A = 25°C.

Parameter 1,2,3		Symbol	Minimum	Maximum	Unit
Secondary Mode, VDD_IO = 3.3 V	ASP_FSYNC input sample/frame rate	F _s	32	768	kHz
	ASP_FSYNC pulse width	t _{HI:FSYNC}	1/f _{ASP_BCLK}	—	ns
	ASP_BCLK frequency	f _{BCLK}	2.048	24.576	MHz
	ASP_BCLK high period	t _{HI:BCLK}	18	—	ns
	ASP_BCLK low period	t _{LO:BCLK}	18	—	ns
	ASP_FSYNC setup time before ASP_BCLK latching edge	t _{SU:FSYNC}	5	—	ns
	ASP_FSYNC hold time after ASP_BCLK latching edge	t _{H:FSYNC}	5	—	ns
	ASP_DIN setup time before ASP_BCLK latching edge	t _{SU:DIN}	10	—	ns
ASP_DIN hold time after ASP_BCLK latching	t _{H:DIN}	5	—	ns	
Primary Mode, VDD_IO = 3.3 V	ASP_FSYNC output sample/frame rate	F _s	32	768	kHz
	ASP_BCLK frequency	f _{BCLK}	2.8224	24.576	MHz
	ASP_BCLK duty cycle	D _{BCLK}	45	55	%
			45	55	%
			42	58	%
			37	63	%
	ASP_FSYNC delay time after ASP_BCLK launching edge	t _{D:BCLK-FSYNC}	0	20	ns
	ASP_DIN setup time before ASP_BCLK latching edge	t _{SU:DIN}	6	—	ns
ASP_DIN hold time after ASP_BCLK latching edge	t _{H:DIN}	5	—	ns	
ASP_x load capacitance	ASP_BCLK ASP_FSYNC	—	0	50	pF
			0	50	pF
Secondary Mode, VDD_IO = 1.8 V	ASP_FSYNC input sample/frame rate	F _s	32	768	kHz
	ASP_FSYNC pulse width	t _{HI:FSYNC}	1/f _{ASP_BCLK}	—	ns
	ASP_BCLK frequency	f _{BCLK}	2.048	24.576	MHz
	ASP_BCLK high period	t _{HI:BCLK}	18	—	ns
	ASP_BCLK low period	t _{LO:BCLK}	18	—	ns
	ASP_FSYNC setup time before ASP_BCLK latching edge	t _{SU:FSYNC}	5	—	ns
	ASP_FSYNC hold time after ASP_BCLK latching edge	t _{H:FSYNC}	5	—	ns
	ASP_DIN setup time before ASP_BCLK latching edge	t _{SU:DIN}	10	—	ns
ASP_DIN hold time after ASP_BCLK latching	t _{H:DIN}	5	—	ns	
Primary Mode, VDD_IO = 1.8 V	ASP_FSYNC output sample/frame rate	F _s	32	768	kHz
	ASP_BCLK frequency	f _{BCLK}	2.8224	24.576	MHz
	ASP_BCLK duty cycle	D _{BCLK}	45	55	%
			45	55	%
			42	58	%
			37	63	%
	ASP_FSYNC delay time after ASP_BCLK launching edge	t _{D:BCLK-FSYNC}	0	20	ns
	ASP_DIN setup time before ASP_BCLK latching edge	t _{SU:DIN}	6	—	ns
ASP_DIN hold time after ASP_BCLK latching edge	t _{H:DIN}	5	—	ns	
ASP_x load capacitance	ASP_BCLK ASP_FSYNC	—	0	50	pF
			0	50	pF

1. The ASP_BCLK launching edge is selectable. Half-cycle mode = ASP_BCLK launching edge is opposite to latching edge. Full-cycle mode = ASP_BCLK launching edge is same as latching edge.

2. ASP timing in I²S and Left-Justified Modes.

Note that ASP_BCLK can be inverted if required; the figure shows the default polarity.

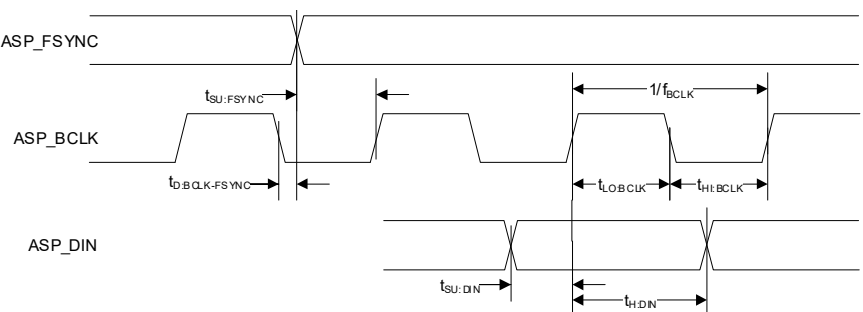

3. ASP timing in TDM Mode.

Note that ASP_BCLK can be inverted if required; the figure shows the default polarity.

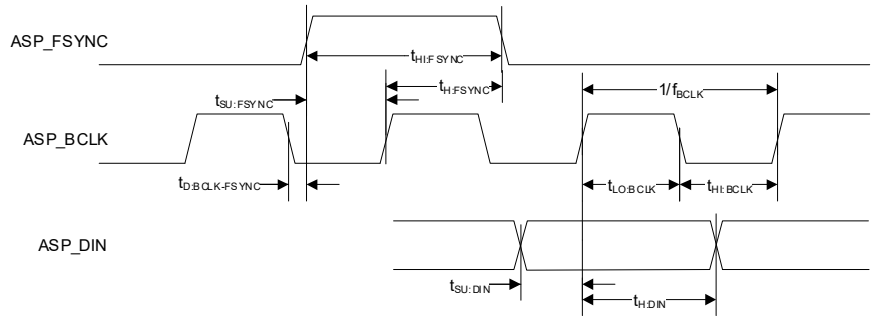
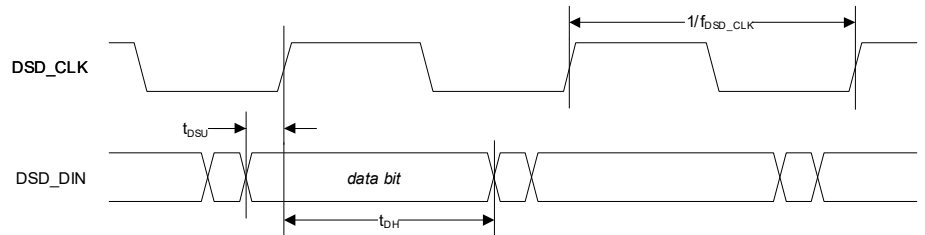

Table 3-12. Switching Specifications—Direct Stream Digital (DSD) Interface

Test conditions (unless specified otherwise): VDD_A = VDD_IO = 3.3 V; VDD_D = 1.2 V (powered from internal LDO); Ground = GND = GND_A = GND_D = 0 V; voltages are with respect to ground; input timings are measured at V_{IL} and V_{IH} thresholds, output timings are measured at V_{OL} and V_{OH} thresholds for VDD_IO logic (as specified in Table 3-8); T_A = 25°C.

Parameter 1,2,3		Symbol	Minimum	Maximum	Unit
Normal Mode	DSD_CLK frequency	f _{DSD_CLK}	2.8224	22.5792	MHz
	DSD_CLK duty cycle	—	45	55	%
	DSD_DIN setup time to active DSD_CLK edge	t _{DSU}	10	—	ns
	DSD_DIN fall time from active DSD_CLK edge	t _{DH}	10	—	ns
Phase Modulation Mode	DSD_CLK frequency	f _{DSD_CLK}	2.8224 5.6448	2.8224 5.6448	MHz MHz
	DSD_CLK duty cycle	—	45	55	%
	DSD_DIN setup time to active DSD_CLK edge	t _{DSU}	10	—	ns
	DSD_DIN fall time from active DSD_CLK edge	t _{DH}	10	—	ns

1. DSD Normal Mode.



2. DSD Phase Modulation, (64fs CLK).

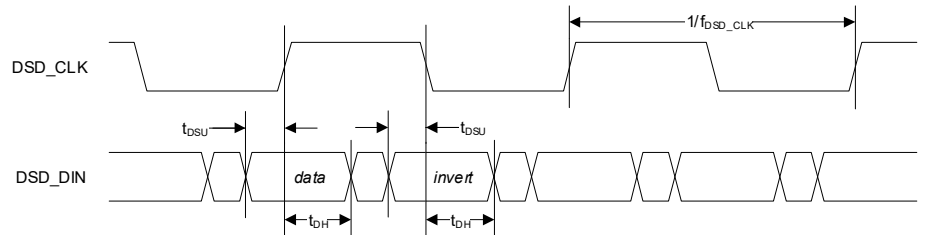

3. DSD Phase Modulation, (128fs CLK).

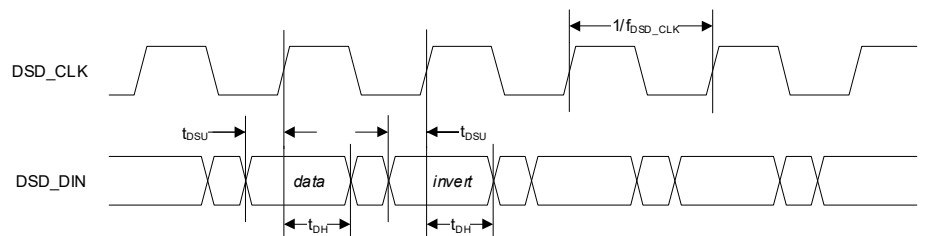

Table 3-13. Switching Specifications—I²C Control Port

Test conditions (unless specified otherwise): VDD_A = VDD_IO = 3.3 V; VDD_D = 1.2 V (powered from internal LDO); Ground = GND = GND_A = GND_D = 0 V; voltages are with respect to ground; input timings are measured at V_{IL} and V_{IH} thresholds, output timings are measured at V_{OL} and V_{OH} thresholds for VDD_IO logic (as specified in Table 3-8); T_A = 25°C.

Parameter ^{1,2}	Symbol	Minimum	Maximum	Unit
SCL clock frequency	f _{SCL}	—	1000	kHz
Clock low time	t _{LOW}	500	—	ns
Clock high time	t _{HIGH}	260	—	ns
Start condition hold time (before first clock pulse)	t _{HDST}	260	—	ns
Setup time for repeated start	t _{SUST}	260	—	ns
Rise time of SCL and SDA	f _{SCL} ≤ 100 kHz	600	1000	ns
	100 kHz < f _{SCL} ≤ 400 kHz	180	300	ns
	400 kHz < f _{SCL} ≤ 1000 kHz	72	120	ns
Fall time of SCL and SDA	f _{SCL} ≤ 100 kHz	6.5	300	ns
	100 kHz < f _{SCL} ≤ 400 kHz	6.5	300	ns
	400 kHz < f _{SCL} ≤ 1000 kHz	6.5	120	ns
Rise time variation between SDA and SCL	—	—	1.67	x
Fall time variation between SDA and SCL	f _{SCL} ≤ 100 kHz	—	100	ns
	100 kHz < f _{SCL} ≤ 400 kHz	—	100	ns
	400 kHz < f _{SCL} ≤ 1000 kHz	—	75	ns
Setup time for stop condition	t _{SUSP}	260	—	ns
SDA setup time to SCL rising	t _{SUD}	50	—	ns
SDA input hold time from SCL falling ³	t _{HDDI}	0	—	ns
Output data valid (Data/ACK) ⁴	f _{SCL} ≤ 100 kHz	—	3450	ns
	100 kHz < f _{SCL} ≤ 400 kHz	—	900	ns
	400 kHz < f _{SCL} ≤ 1000 kHz	—	450	ns
Bus free time between transmissions	t _{BUF}	500	—	ns
SDA bus capacitance	C _B	—	550	pF
SCL/SDA pull-up resistance	R _P	500	—	Ω
Pulse width of spikes to be suppressed	t _{ps}	0	50	ns

1. All timing is relative to thresholds specified in Table 3-8, V_{IL} and V_{IH} for input signals, and V_{OL} and V_{OH} for output signals.

2. I²C control-port timing.

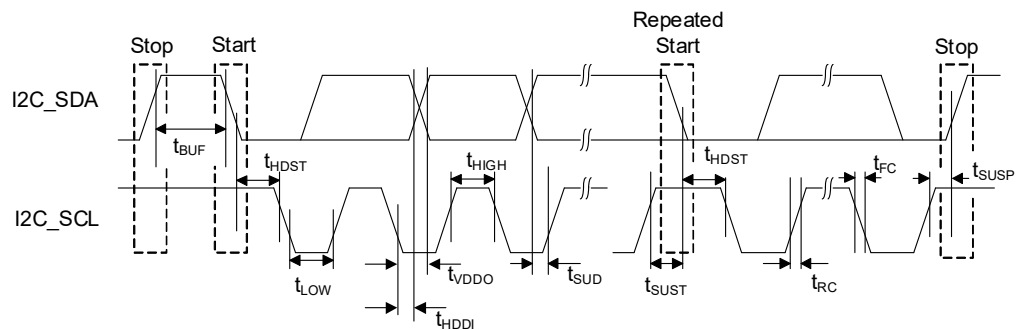

3. Data must be held long enough to bridge the transition time, t_{FC}, of SCL.

4. Time from falling edge of SCL until data output is valid.

Table 3-14. Switching Specifications—SPI Control Port

Test conditions (unless specified otherwise): VDD_A = VDD_IO = 3.3 V; VDD_D = 1.2 V (powered from internal LDO); Ground = GND = GND_A = GND_D = 0 V; voltages are with respect to ground; input timings are measured at V_{IL} and V_{IH} thresholds, output timings are measured at V_{OL} and V_{OH} thresholds for VDD_IO logic (as specified in Table 3-8); T_A = 25°C.

Parameter ¹	Symbol	Minimum	Maximum	Unit
SPI_SCK frequency	f _{SCY}	—	24	MHz
SPI_CS falling edge to SPI_SCK rising edge	t _{SSU}	5	—	ns
SPI_SCK falling edge to SPI_CS rising edge	t _{SHO}	0.5	—	ns
SPI_SCK pulse width low	t _{SCL}	18.5	—	ns
SPI_SCK pulse width high	t _{SCH}	18.5	—	ns
SPI_SDI to SPI_SCK setup time	t _{DSU}	5	—	ns
SPI_SDI to SPI_SCK hold time	t _{DHO}	2.5	—	ns
SPI_SCK falling edge to SPI_SDO transition	t _{DL}	0	15	ns
SPI_CS rising edge to SPI_SDO output high-Z	—	0	15	ns
Bus free time between active SPI_CS	t _{SH}	20	—	ns

1. SPI control-port timing.

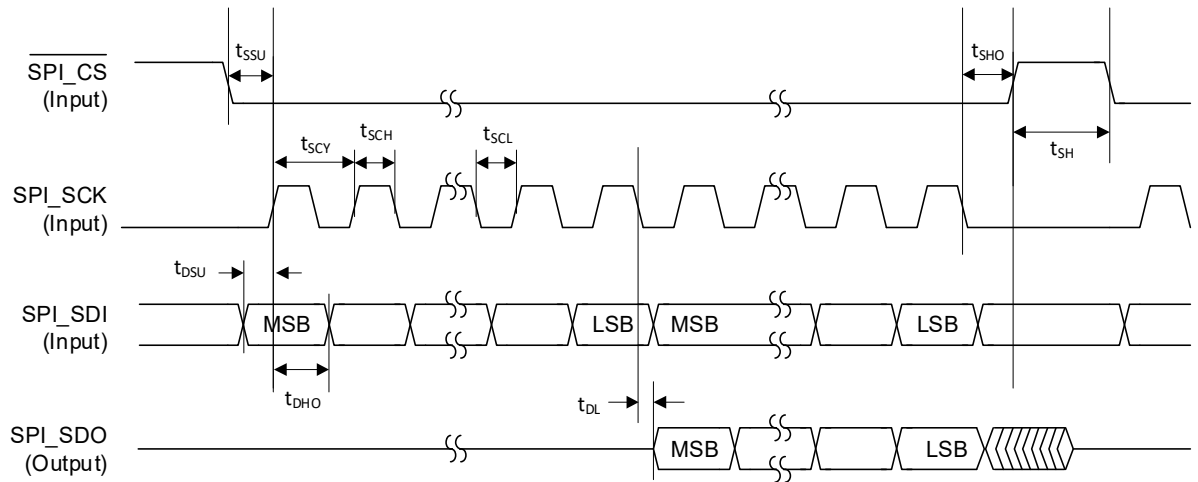

4 Functional Description

4.1 Device Power and Reset

The CS4308P is powered using VDD_A1, VDD_A2, VDD_D, and VDD_IO external supplies.

Notes: The VDD_A1 and VDD_A2 rails should be tied together and powered from a single supply. The associated power domain is referred to as VDD_A.

The digital supply, VDD_D, is powered from an internal LDO regulator. The output of the LDO regulator is provided on the LDO_D_FILT pin—the VDD_D pin should be connected to LDO_D_FILT.

There are no power-sequencing requirements—supplies can be enabled in any order.

The CS4308P is in reset if the $\overline{\text{RESET}}$ pin is asserted (Logic 0), or if the VDD_A or VDD_D supply is below the respective reset threshold defined in [Table 3-9](#).

All ground pins, including the ground paddle, must be tied to a common ground plane directly underneath the CS4308P.

4.2 Hardware Configuration

The CS4308P supports hardware and software control modes. In hardware mode, the device configuration is determined entirely by external resistors connected to the hardware-control pins. In software mode, the I²C/SPI control port is used to configure the device.

Note: The hardware-control pins CONFIG1 and CONFIG5 are powered by VDD_A. The CONFIG2, CONFIG3, and CONFIG4 pins are powered by VDD_IO. Care must be taken to ensure any external pull-up resistors on these pins are connected to the applicable power domain.

In hardware mode, the audio serial port (ASP) configuration is selected using the CONFIG1 and CONFIG2 pins as described in [Table 4-1](#). See [Section 4.4](#) for more details of the sample-rate selection. See [Section 4.7](#) for more details of the ASP operation.

Note that the DSD interface ([Section 4.8](#)) is not supported in hardware control mode.

Table 4-1. Hardware Control—ASP Configuration

Pin Name	Pin Configuration		Description
CONFIG1	Pull-up to VDD_A	0 Ω	Software control mode (I ² C/SPI)
		4.7 k Ω	ASP Primary Mode, 44.1 kHz, 48 kHz sample rate
		22 k Ω	ASP Primary Mode, 88.2 kHz, 96 kHz sample rate
		100 k Ω	ASP Primary Mode, 176.4 kHz, 192 kHz sample rate
	Pull-down to GND_A	100 k Ω	ASP Secondary Mode, 176.4 kHz, 192 kHz sample rate
		22 k Ω	ASP Secondary Mode, 88.2 kHz, 96 kHz sample rate
		4.7 k Ω	ASP Secondary Mode, 44.1 kHz, 48 kHz sample rate
		0 Ω	ASP Secondary Mode, autodetect sample rate ^{1,2}
CONFIG2	Pull-up to VDD_IO	0 Ω	ASP TDM Mode—minimum time slots ³
		4.7 k Ω	ASP TDM Mode—maximum time slots ⁴
		22 k Ω	—
		100 k Ω	—
	Pull-down to GND_D	100 k Ω	—
		22 k Ω	—
		4.7 k Ω	ASP Left-Justified Mode
		0 Ω	ASP I ² S Mode

1. Valid sample rates for autodetect are 32, 44.1, 48, 88.2, 96, 176.4, and 192 kHz.

2. Autodetect sample rate is only supported in MCLK = 256 fs(base), MCLK = 512 fs(base), or MCLK 1024 fs(base) clocking configurations (see [Table 4-3](#)).

3. The ASP data format is configured to support the minimum number of time slots necessary for the 8-channel CS4308P input.

4. The ASP data format is configured to support the maximum number of time slots for the applicable BCLK rate.

If the ASP is configured for TDM data format with maximum time slots, the TDM slot selection is determined using the CONFIG3 pin as described in [Table 4-2](#). See [Section 4.7](#) for more details of the ASP TDM modes.

Table 4-2. Hardware Control—TDM Slot Selection

Pin Name	Pin Configuration		Description
CONFIG3	Pull-up to VDD_IO	0 Ω	Slots 8–15 [1]
		4.7 kΩ	
		22 kΩ	
		100 kΩ	
	Pull-down to GND_D	100 kΩ	Slots 0–7
		22 kΩ	
		4.7 kΩ	
		0 Ω	

1. Slots 8–15 are only valid in 16-slot TDM Mode.

The clock-reference and ASP channel-ordering configuration is determined using the CONFIG4 pin as described in [Table 4-3](#). See [Section 4.4](#) for more details of the CS4308P clocking architecture. See [Section 4.7.5](#) for more details of the ASP reverse channel-order option.

Table 4-3. Hardware Control—Clocking Configuration

Pin Name	Pin Configuration		Clock Reference 1,2,3,4	PLL	Channel Order
CONFIG4	Pull-up to VDD_IO	0 Ω	BCLK = 64 fs	Enabled	Default
		4.7 kΩ	MCLK = 1024 fs(base)	Bypass	Default
		22 kΩ	MCLK = 256 fs(base)	Enabled	Default
		100 kΩ	MCLK = 512 fs(base)	Enabled	Default
	Pull-down to GND_A	100 kΩ	MCLK = 512 fs(base)	Enabled	Reversed
		22 kΩ	MCLK = 256 fs(base)	Enabled	Reversed
		4.7 kΩ	MCLK = 1024 fs(base)	Bypass	Reversed
		0 Ω	BCLK = 64 fs	Enabled	Reversed

1. fs = sample rate, 44.1, 48, 88.2, 96, 176.4, or 192 kHz.

2. fs(base) is the base sample rate. fs(base) = 48 kHz for 48 kHz-related sample rates; fs(base) = 44.1 kHz for 44.1 kHz-related sample rates.

3. BCLK 64 fs configuration is only supported in ASP Secondary Mode.

4. Autodetect sample rate (see [Table 4-1](#)) is only supported in MCLK = 256 fs(base), MCLK = 512 fs(base), or MCLK 1024 fs(base) clocking configurations.

In hardware mode, the digital filter is selected using the CONFIG5 pin as described in [Table 4-4](#). Note the filter selection is also dependent on the sample rate. See [Section 4.6](#) for more details of the digital filters.

Table 4-4. Hardware Control—DAC Output Digital Filter Selection

Pin Name	Pin Configuration		DAC Interpolation Filter		High-Pass Filter (HPF)
			32–48 kHz Sample Rate 1	88.2–192 kHz Sample Rate	
CONFIG5	Pull-up to VDD_A	0 Ω	Minimum phase, slow roll-off	Minimum phase, balanced roll-off	Bypass
		4.7 kΩ	Minimum phase, fast roll-off	Minimum phase, fast roll-off	Bypass
		22 kΩ	Linear phase, slow roll-off	Linear phase, balanced roll-off	Bypass
		100 kΩ	Linear phase, fast roll-off	Linear phase, fast roll-off	Bypass
	Pull-down to GND_A	100 kΩ	Linear phase, fast roll-off	Linear phase, fast roll-off	Enabled
		22 kΩ	Linear phase, slow roll-off	Linear phase, balanced roll-off	Enabled
		4.7 kΩ	Minimum phase, fast roll-off	Minimum phase, fast roll-off	Enabled
		0 Ω	Minimum phase, slow roll-off	Minimum phase, balanced roll-off	Enabled

1. Fast roll-off filters are supported for all sample rates. Slow roll-off filters are not valid for 32 kHz sample rate.

In hardware mode, the device configuration is latched when reset is released (either power-on reset or deassertion of the $\overline{\text{RESET}}$ pin). In hardware mode, the configuration cannot be changed while the device is operational. To update the device configuration, the $\overline{\text{RESET}}$ pin must be asserted (Logic 0), or the device power cycled, in order to read new settings on the CONFIGx pins.

If software mode is selected (i.e., CONFIG1 has a 0 Ω pull-up to VDD_A), the ASP configuration and digital-filter selection are controlled by register writes via the applicable control interface. Unused CONFIGx pins should be terminated as described in [Section 1.3](#).

Notes: In software mode, the CONFIG2 and CONFIG3 pins can optionally be used to support the DSD interface (see [Section 4.8](#)).

In software mode, the CONFIG5 pin is used to select the I²C target address (see [Section 4.9](#)). If the SPI control interface is used, it is recommended to connect the CONFIG5 pin to GND.

4.3 Software Configuration

Software control mode is enabled if the CONFIG1 pin is connected to VDD_A. In software control mode, the CS4308P is configured by writing to control registers using the control port.

The control port supports I²C and SPI modes of operation; the applicable mode is detected automatically on the respective interface pins. In I²C mode, the target address is selectable using the CONFIG5 pin. See [Section 4.9](#) for further details of the I²C/SPI control port.

In software control mode, [GLOBAL_EN](#) is used as the global control field for enabling/disabling the CS4308P functions. The device should be configured using the applicable control registers before setting [GLOBAL_EN](#).

Notes: The clocking ([Section 4.4](#)) and ASP ([Section 4.7](#)) control registers are only valid on the rising edge of [GLOBAL_EN](#). Writing to these registers has no effect at any other time. It is recommended to select the disabled state ([GLOBAL_EN](#) = 0) before writing to these registers.

See [Section 4.5.1](#) to minimize the CS4308P power consumption when all output paths are disabled.

A reset of the CS4308P can be triggered by writing 0x5A to the [SW_RESET](#) field. A software reset disables all functions and sets the control registers to their default states.

4.4 System Clocking

Clocking for the CS4308P is provided from the digital audio input (ASP_BCLK or DSD_CLK) or else using the dedicated MCLK input.

The integrated PLL can be used to generate the internal system clock from the external reference. The MCLK signal can be used as a direct clock source, bypassing the PLL. If ASP_BCLK or DSD_CLK is selected as the clock reference, the PLL is always used and cannot be bypassed.

In ASP Secondary Mode, the FSYNC input is used to control the DAC-conversion timing, enabling multiple CS4308P devices to operate synchronously in a system. See [Section 4.7](#) for more details of the ASP.

The clocking architecture is illustrated in Fig. 4-1.

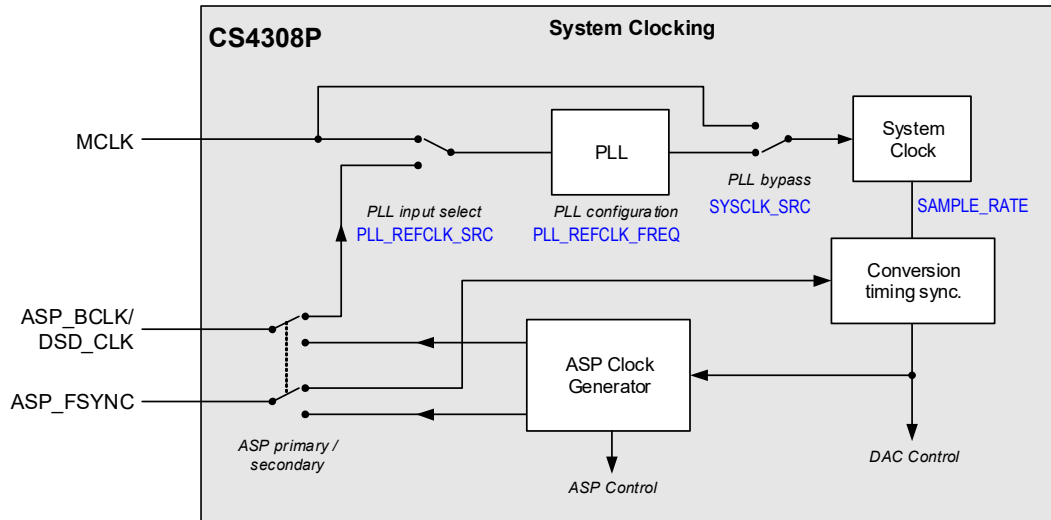

Figure 4-1. System Clocking

4.4.1 Hardware Control Mode

In hardware control mode, the clocking configuration is determined by the CONFIG4 pin (see Section 4.2). Four possible clocking configurations are supported as follows:

- BCLK reference—64 fs, PLL enabled
- MCLK reference—1024 fs(base), PLL bypass
- MCLK reference—256 fs(base), PLL enabled
- MCLK reference—512 fs(base), PLL enabled

The clocking configuration is defined with reference to the sample rate (fs). Note that fs(base) is the *base sample rate*; fs(base) = 48 kHz for 48 kHz-related sample rates, fs(base) = 44.1 kHz for 44.1 kHz-related sample rates.

The sample rate is selected using the CONFIG1 pin as described in Section 4.2. Sample rates 44.1 kHz–192 kHz can be configured, or else the autodetect option (32 kHz–192 kHz) automatically configures the device according to the ASP interface clock signals. Note the autodetect sample-rate option is only valid if the clock reference source is MCLK and the ASP is operating in Secondary Mode (see Section 4.7).

The BCLK 64 fs configuration enables the CS4308P to be clocked from the audio serial port (ASP) operating in Secondary Mode, with no requirement for any other clock reference. Note that, in the BCLK 64 fs clocking configuration, the ASP data format must be either I²S or left-justified.

The MCLK-referenced configurations use a fixed clock frequency of 12.288 / 24.576 / 49.152 MHz (for 48 kHz-related sample rates), or 11.2896 / 22.5792 / 45.1584 MHz (for 44.1 kHz-related sample rates).

The supported clocking configurations are summarized in Table 4-5.

Table 4-5. System Clock Configuration

Description	PLL Select	Reference Source	Reference Frequency	ASP Operating Conditions ¹
BCLK = 64 fs	Enabled	BCLK	64 × sample rate	Secondary Mode only, I ² S or left-justified data formats, sample rates 44.1–192 kHz, sample-rate autodetect not supported.
MCLK = 1024 fs(base)	Bypass	MCLK	49.152 MHz or 45.1584 MHz	Primary or Secondary Mode, I ² S, left-justified, or TDM data formats, sample rates 32–192 kHz, sample-rate autodetect supported.
MCLK = 256 fs(base)	Enabled	MCLK	12.288 MHz or 11.2896 MHz	
MCLK = 512 fs(base)	Enabled	MCLK	24.576 MHz or 22.5792 MHz	

1. See Section 4.7 for details of the audio serial port (ASP).

The sample rate must be related to the system clock reference as described in [Table 4-6](#).

Table 4-6. Sample Rate Options

Reference Source	Clocking Configuration	Reference Frequency (MHz)	Sample Rate (kHz)
BCLK	BCLK = 64 fs	2.8224	44.1
		5.6448	88.2
		11.2896	176.4
		3.072	48
		6.144	96
		12.288	192
MCLK	MCLK = 1024 fs(base)	45.1584	44.1, 88.2, 176.4
		49.152	32, 48, 96, 192
	MCLK = 256 fs(base)	11.2896	44.1, 88.2, 176.4
		12.288	32, 48, 96, 192
	MCLK = 512 fs(base)	22.5792	44.1, 88.2, 176.4
		24.576	32, 48, 96, 192

Note that, if MCLK is configured as the clock source (with or without PLL) and the ASP is configured in Secondary Mode, the external clocks (MCLK, BCLK, and FSYNC) must be derived from a common clock source. The clocks must be synchronized, but the phase difference is not important.

4.4.2 Software Control Mode—ASP Input

In software (I²C/SPI) control mode, with the ASP selected as the audio source (see [Section 4.7](#)), the clocking configuration is selected using the following control fields:

- The sample rate is configured using [SAMPLE_RATE](#). Sample rates 32 kHz–768 kHz can be configured, or else the autodetect option automatically configures the device according to the ASP interface signals. The sample rate must be related to the system clock reference as described in [Table 4-8](#).

Note that the sample-rate autodetect option is only valid if all the following conditions are met:

- Sample rate is 32 kHz–192 kHz
- The clock reference source is MCLK
- ASP is operating in Secondary Mode (see [Section 4.7](#)).
- The system clock source is selected using [SYSCLK_SRC](#). The clock source can be either MCLK or the output from the PLL. If MCLK is selected (i.e., PLL bypass), the MCLK frequency must be 49.152 MHz (for 48 kHz-related sample rates) or 45.1584 MHz (for 44.1 kHz-related sample rates).
- The input reference to the PLL is selected using [PLL_REFCLK_SRC](#). The reference can be either MCLK or BCLK. Note the BCLK reference is only valid if the ASP is operating in Secondary Mode.
- The frequency of the PLL input reference is configured using [PLL_REFCLK_FREQ](#).

The supported clocking configurations are summarized in [Table 4-7](#).

Table 4-7. System Clock Configuration

SYSCLK_SRC	PLL_REFCLK_SRC	Description	Reference Frequency	Sample Rate Autodetect Supported
0	X	MCLK reference, PLL bypass	49.152 MHz or 45.1584 MHz	Yes
1	1	MCLK reference, PLL enabled	Configured by PLL_REFCLK_FREQ	Yes
1	0	BCLK reference, PLL enabled		No

The sample rate must be related to the system clock reference as described in [Table 4-8](#).

Table 4-8. Sample Rate Options

Reference Frequency (MHz)	PLL_REFCLK_FREQ	Sample Rate (kHz) ^{1,2}
2.8224	00	44.1, 88.2, 176.4, 352.8, 705.6
5.6448	01	
11.2896	10	
22.5792	11	
45.1584	See note ^[3]	
3.072	00	32, 48, 96, 192, 384, 768
6.144	01	
12.288	10	
24.576	11	
49.152	See note ^[3]	

1. Sample rate is configured using [SAMPLE_RATE](#).
2. Sample rates 705.6 kHz and 768 kHz are supported for a maximum of four channels only (i.e., with output channels summed as described in [Section 4.5.3](#)).
3. Only valid in PLL-bypass configuration. The [PLL_REFCLK_FREQ](#) setting is not used.

Note that, if MCLK is configured as the clock source (with or without PLL) and the ASP is configured in Secondary Mode, the external clocks (MCLK, BCLK, and FSYNC) must be derived from a common clock source. The clocks must be synchronized, but the phase difference is not important.

4.4.3 Software Control Mode—DSD Input

In software (I²C/SPI) control mode, with the DSD interface selected as the audio source (see [Section 4.8](#)), the clocking configuration is selected using the following control fields:

- The system clock source is selected using [SYSCLK_SRC](#). The clock source can be either MCLK or the output from the PLL. If MCLK is selected (i.e., PLL bypass), the MCLK frequency must be 45.1584 MHz.
- The input reference to the PLL is selected using [PLL_REFCLK_SRC](#). The reference can be either MCLK or DSD_CLK. The DSD_CLK frequency is configured using [DSD_OSR](#) as described in [Section 4.8.2](#).
- The frequency of the PLL input reference is configured using [PLL_REFCLK_FREQ](#).

The supported clocking configurations are summarized in [Table 4-9](#).

Table 4-9. System Clock Configuration

SYSCLK_SRC	PLL_REFCLK_SRC	Description	Reference Frequency
0	X	MCLK reference, PLL bypass	45.1584 MHz
1	1	MCLK reference, PLL enabled	Configured by PLL_REFCLK_FREQ
1	0	DSD_CLK reference, PLL enabled	

The supported reference frequencies for the PLL are noted in [Table 4-10](#).

Table 4-10. PLL Reference Selection

Reference Frequency (MHz)	PLL_REFCLK_FREQ
2.8224	00
5.6448	01
11.2896	10
22.5792	11
45.1584	See note ^[1]

1. Only valid in PLL-bypass configuration. The [PLL_REFCLK_FREQ](#) setting is not used.

Note that, if MCLK is configured as the clock source (with or without PLL), the external clocks (MCLK and DSD_CLK) must be derived from a common clock source. The clocks must be synchronized, but the phase difference is not important.

4.5 DAC and Analog Output

The CS4308P supports eight analog output channels, each incorporating a high-performance sigma-delta digital-to-analog converter (DAC). Digital volume and mute control is provided on each output channel.

Note that the digital volume and mute controls are supported in software (I²C/SPI) control mode only. In hardware control mode, all channels are enabled with 0 dB gain.

4.5.1 DAC Path Enable

The analog output and DAC paths are enabled using `OUTx_DAC_EN` (where x indicates the channel number 1–8).

To minimize power consumption when all output paths are disabled, the DAC reference circuit can be disabled by setting `DAC_REF_DISABLE`. If this bit is set, all output paths are disabled, regardless of the `OUTx_DAC_EN` bits.

Note: Power consumption is only reduced if the output paths have previously been enabled. Until they are enabled for the first time, the power consumption is already minimized as far as possible.

When the output paths are enabled for the first time after power-up or after the DAC reference has been disabled, the paths do not become active until a startup delay has elapsed. The time delay (1 s default) is applied when the output paths are enabled using `DAC_REF_DISABLE`, `GLOBAL_EN`, or `OUTx_DAC_EN`; the delay ensures the noise floor of the output path has settled before it becomes active.

The startup delay can be disabled using `STARTUP_DELAY_EN`. The delay duration is configurable using `STARTUP_DELAY_TIME`. If the delay is disabled or is shorter than 1 s, an elevated noise floor (~20 dB above specification) may be observed during the settling period.

The polarity of the DAC output can be inverted using `OUTx_INV` for the respective channel.

4.5.2 Digital Volume and Mute

The DAC signal path incorporates a digital volume control, supporting a gain range of –127.5 dB to 0 dB in 0.5 dB steps. Volume ramping and digital mute is also supported.

The digital volume is configured using `OUTx_VOL` for the respective output channel. The digital mute is enabled by setting `OUTx_MUTE`.

Writing to the volume or mute fields has no effect on the signal path until a 1 is written to `OUT_VU`. Writing 1 to `OUT_VU` causes the volume and mute settings to be updated on all output paths simultaneously.

When the volume or mute is changed, the gain of the affected signal paths is ramped up or down to the new setting. For increasing gain, the rate is controlled by `OUT_RAMP_RATE_INC`; for decreasing gain, the rate is controlled by `OUT_RAMP_RATE_DEC`.

Note: The `OUT_RAMP_RATE_INC` and `OUT_RAMP_RATE_DEC` fields should not be changed while a volume ramp is in progress.

4.5.3 DAC Output Summing

The CS4308P supports the option to combine the DAC signal paths in groups of two, four, or eight channels; this can be used to achieve enhanced dynamic-range performance on the respective paths. A six-channel summing mode is also supported, with DAC1–DAC4 operating in pairs, with DAC5–DAC8 operating individually.

In the summing configuration, the signal paths are routed and controlled differently to normal operation—the input signals are routed to groups of two or more DACs (depending on the selected configuration), and the grouped paths are each controlled as a single channel.

The DAC output summing is configured using `OUT_SUM_MODE`. The supported options are described in [Table 4-11](#).

Note: The `OUT_SUM_MODE` field should not be changed while `GLOBAL_EN` is set. The `GLOBAL_EN` bit should always be cleared before writing to `OUT_SUM_MODE`.

Table 4-11. DAC Output Summing

Configuration	Description	Output Summing Configuration	Summed Channel Number
Default	8-channel input	OUT1–OUT8 as individual outputs	1–8
Four DACs combined in groups of two	6-channel input	OUT1+OUT2	1
		OUT3+OUT4	2
		OUT5	3
		OUT6	4
		OUT7	5
		OUT8	6
All DACs combined in groups of two	4-channel input	OUT1+OUT2	1
		OUT3+OUT4	2
		OUT5+OUT6	3
		OUT7+OUT8	4
DACs combined in groups of four	2-channel input	OUT1+OUT2+OUT3+OUT4	1
		OUT5+OUT6+OUT7+OUT8	2
DACs combined as a group of eight	1-channel input	OUT1+OUT2+OUT3+OUT4+ OUT5+OUT6+OUT7+OUT8	1

In the summing configuration, the respective analog output connections must be linked externally to achieve the performance enhancement. The analog outputs are current-mode outputs; the external linking of the outputs results in the summing of the respective output signals.

Note: The increased current in the summing configuration affects the choice of components for the output buffer—see [Section 4.5.4](#) for further details.

The grouped output paths are configured using the control registers associated with the respective summed channel number (see [Table 4-11](#)). For example, the OUT3+OUT4 group is configured using the OUT2 control registers.

Typical connections, with outputs combined in groups of two, are shown in [Fig. 4-2](#).

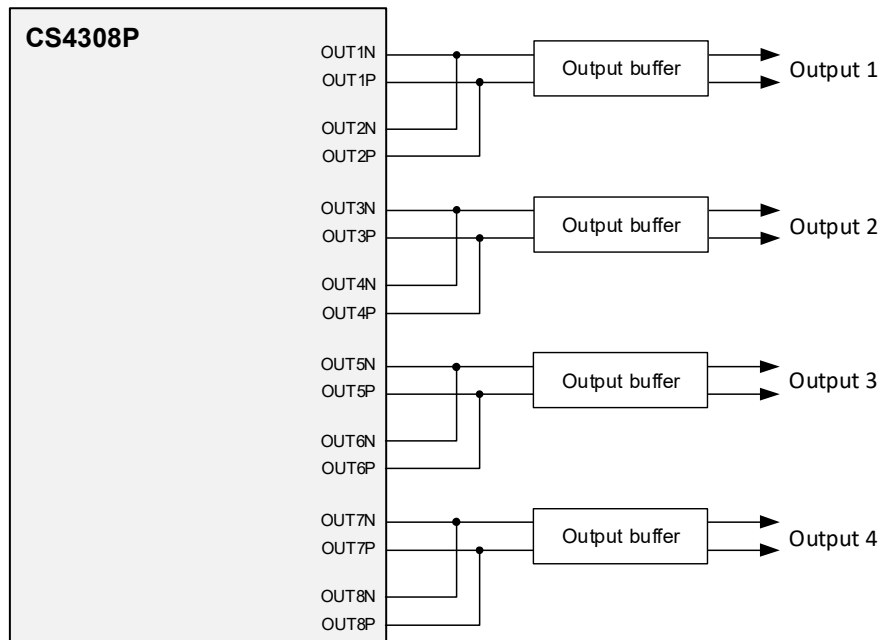

Figure 4-2. Output Summing

4.5.4 External Components

The analog output channels are supported using external buffer circuits, also incorporating anti-alias filters. A typical buffer circuit is shown in Fig. 4-3; the typical buffer circuit shown produces a 2 V_{RMS} differential output from a full-scale (0 dBFS) digital input.

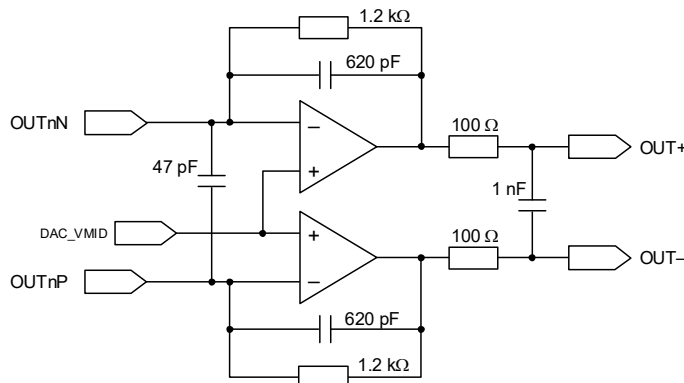

Figure 4-3. Output Buffer

In the summing configuration (see Section 4.5.3), the increased output current affects the choice of components for the output buffer. The feedback resistance must be selected according to the number of outputs that are summed, as described in Table 4-12. The 47 pF capacitance should be changed to 100 pF in the output-summing configurations.

Table 4-12. Output Buffer Components

Configuration	Capacitance	Resistance
No summing	47 pF	1.2 kΩ
2 outputs summed	100 pF	600 Ω
4 outputs summed	100 pF	300 Ω
8 output summed	100 pF	150 Ω

Note: The specified resistance assumes 2 V_{RMS} full-scale output

Note that other output-buffer circuit topologies are possible, including support for single-ended output signals.

4.6 Digital Filter Selection

The DAC output path incorporates an interpolation filter and a high-pass filter. Six types of filter are supported:

- Fast roll-off, minimum phase
- Fast roll-off, linear phase
- Slow roll-off, minimum phase
- Slow roll-off, linear phase
- Balanced roll-off, minimum phase
- Balanced roll-off, linear phase

The phase-response options is characterized as follows:

- The **minimum-phase** filters offer the lowest latency and an impulse response with no pre-ringing, at the expense of potential in-band phase distortion.
- The **linear-phase** filters have no phase distortion, but also higher latency and a symmetric impulse response.

The frequency-response options are characterized as follows:

- The **fast roll-off** filters maximize the audio signal bandwidth (as a function of the selected sample rate) and provide deep stopband attenuation. The signal bandwidth and stopband attenuation are prioritized over impulse response and group delay. The deep stopband attenuation minimizes out-of-band noise and aliased signal content.

- The **slow roll-off** filters are optimized for impulse response and group delay, with flat passband over the audible range to 20 kHz and a more relaxed stopband specification. The enhanced impulse response may improve perceived sound quality, especially for transient signal content.

Note the slow roll-off filters provide less stopband attenuation than other filter types. To avoid out-of-band noise above the stopband attenuation level, the system design must ensure the DAC input data does not contain significant energy above 20 kHz (for 48 kHz sample rate), 30 kHz (for 96 kHz sample rate), or 40 kHz (for 192 kHz sample rate).

- The **balanced roll-off** filters offer a superior impulse response and group delay as compared with the fast roll-off filters, while retaining a flat passband over the audible range to 20 kHz and deep stopband attenuation.

The supported filter options for different sample rates are indicated in [Table 4-13](#).

Table 4-13. Digital Filter Options

Description	Sample Rate (kHz)											
	32	44.1	48	88.2	96	176.4	192	352.8	384	705.6	768	
Fast roll-off, minimum phase	Yes	Yes	Yes	Yes	Yes	Yes	Yes	Yes	Yes	Yes	Yes	Yes
Fast roll-off, linear phase	Yes	Yes	Yes	Yes	Yes	Yes	Yes	Yes	Yes	Yes	Yes	Yes
Slow roll-off, minimum phase	—	Yes	Yes	Yes	Yes	Yes	Yes	—	—	—	—	—
Slow roll-off, linear phase	—	Yes	Yes	Yes	Yes	Yes	Yes	—	—	—	—	—
Balanced roll-off, minimum phase	—	—	—	Yes	Yes	Yes	Yes	Yes	Yes	Yes	Yes	Yes
Balanced roll-off, linear phase	—	—	—	Yes	Yes	Yes	Yes	Yes	Yes	Yes	Yes	Yes

In hardware control mode, the filter selection is determined by the CONFIG5 pin (see [Section 4.2](#)). In software (I²C/SPI) control mode, the interpolation filter is selected using `OUT_FILTER_SEL`; the high-pass filter is enabled using `OUT_HPF_EN`.

Performance plots showing the characteristics of the interpolation filters are shown in [Section 7](#).

A deemphasis filter can also be enabled in the DAC output path. The filter provides standard *Red Book* deemphasis, with corner frequencies corresponding to 15 μs/50 μs time constants, as illustrated in [Fig. 4-4](#).

The deemphasis filter is supported for 32 kHz, 44.1 kHz, and 48 kHz sample rates. The filter is enabled using `OUT_DEEMPH_EN`. If the sample rate is 44.1 kHz or 48 kHz, the applicable rate must be configured using `OUT_DEEMPH_FILT_SEL`.

Note: The deemphasis filter is not supported for sample rates above 48 kHz; enabling the filter at sample rates higher than 48 kHz has no effect.

The de-emphasis filter response is illustrated in [Fig. 4-4](#).

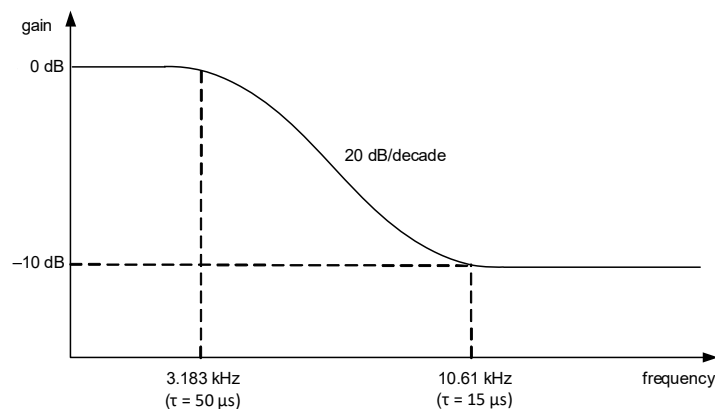

Figure 4-4. Deemphasis Filter Response

Note the interpolation and deemphasis filters are not supported on the DSD signal path (see [Section 4.8](#)).

4.7 Audio Serial Port (ASP)

The multichannel ASP supports the input of digital audio samples to the CS4308P. The ASP can be configured as a primary or secondary interface, and supports I²S, left-justified, and TDM data formats. The audio samples can be distributed across four data lines, enabling additional bandwidth and flexibility.

In hardware control mode, the ASP data format is determined by the CONFIGx pins (see [Section 4.2](#)). In software (I²C/SPI) control mode, the ASP data format is configured using register fields.

In hardware mode, sample rates 32 kHz–192 kHz are supported. In software mode, the CS4308P supports sample rates 32 kHz–384 kHz. Note that 768 kHz sample rate is also supported for four channels or fewer (i.e., if channel summing is enabled as described in [Section 4.5.3](#)).

Note that the ASP interface is not supported if the DSD interface is enabled (see [Section 4.8](#)).

4.7.1 Primary and Secondary Operation

The ASP interface can operate as a primary or secondary interface. In the primary configuration, the BCLK and FSYNC signals are generated by the CS4308P. In the secondary configuration, the BCLK and FSYNC pins are inputs, allowing another device to drive the respective signals.

In hardware control mode, the ASP is configured as a primary or secondary interface using the CONFIG1 pin (see [Section 4.2](#)). In software control mode, the ASP primary/secondary configuration is selected using `ASP_PRIMARY`.

The ASP operation as a primary or secondary interface is illustrated in [Fig. 4-5](#) and [Fig. 4-6](#).

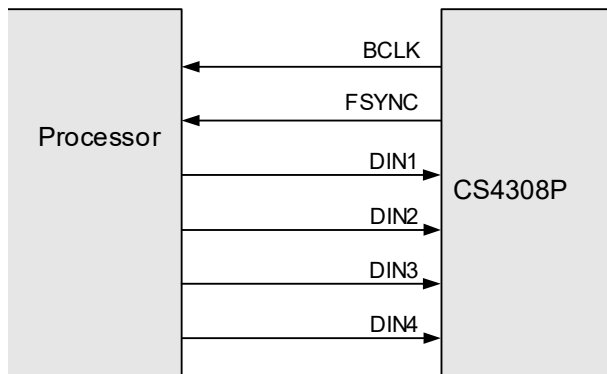

Figure 4-5. Primary Mode

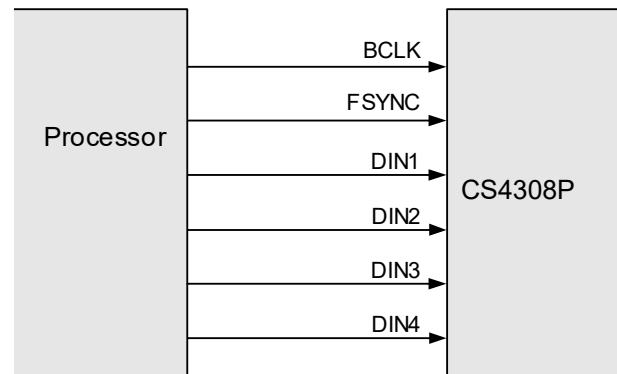

Figure 4-6. Secondary Mode

4.7.2 ASP Data Formats

The ASP interface can be configured to operate in I²S, left-justified, or TDM data formats as illustrated in Fig. 4-7 through Fig. 4-9. The data-bit order is MSB first in each case; data words are encoded in 2's complement (signed, fixed-point) format. Each audio sample is allocated a time slot within the FSYNC frame. Multiple data lines provide capacity to support different audio channels concurrently on different data pins.

- In I²S Mode, the MSB is valid on the second BCLK rising edge following a FSYNC transition. The other bits up to the LSB are valid on each successive BCLK cycle. Depending on word length, BCLK frequency, and sample rate, there may be unused BCLK cycles between the LSB of one sample and the MSB of the next.

I²S Mode data format is shown in Fig. 4-7.

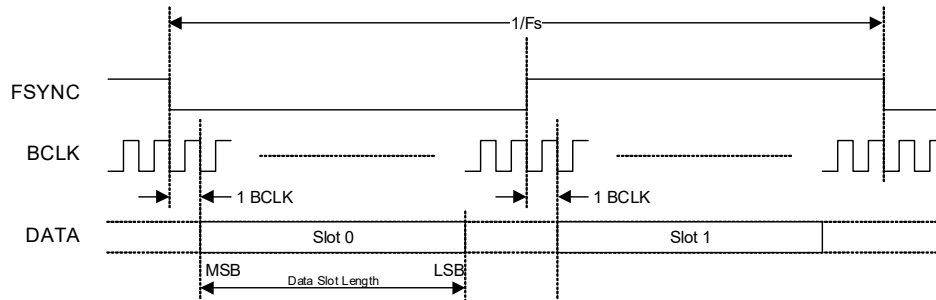

Figure 4-7. I²S Data Format

- In Left-Justified Mode, the MSB is valid on the first BCLK rising edge following a FSYNC transition. The other bits up to the LSB are valid on each successive BCLK cycle. Depending on word length, BCLK frequency, and sample rate, there may be unused BCLK cycles between the LSB of one sample and the MSB of the next.

Left-Justified Mode data format is shown in Fig. 4-8.

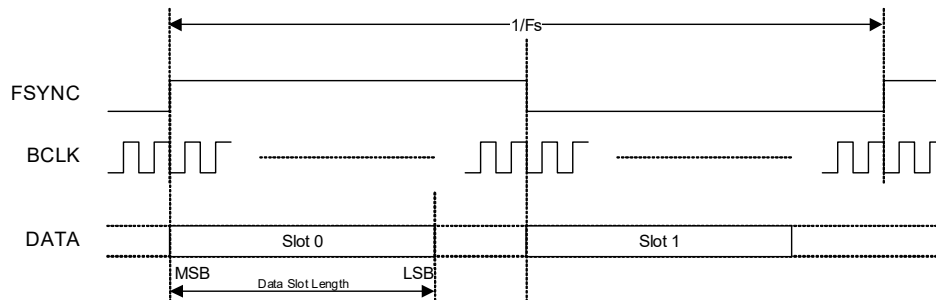

Figure 4-8. Left-Justified Data Format

- In TDM modes, the MSB of the first channel is valid on the second BCLK rising edge following the rising FSYNC edge. Subsequent channels follow immediately after the previous one. Depending on word length, BCLK frequency, and sample rate, there may be unused BCLK cycles between the LSB of the last channel data and the start of the next FSYNC frame.

In Primary Mode, the FSYNC output resembles the frame pulse shown in Fig. 4-9. In Secondary Mode, the FSYNC pulse duration can be anything less than $1/F_s$, provided the falling edge of the frame pulse occurs at least one BCLK period before the rising edge of the next frame pulse.

TDM Mode data format is shown in Fig. 4-9.

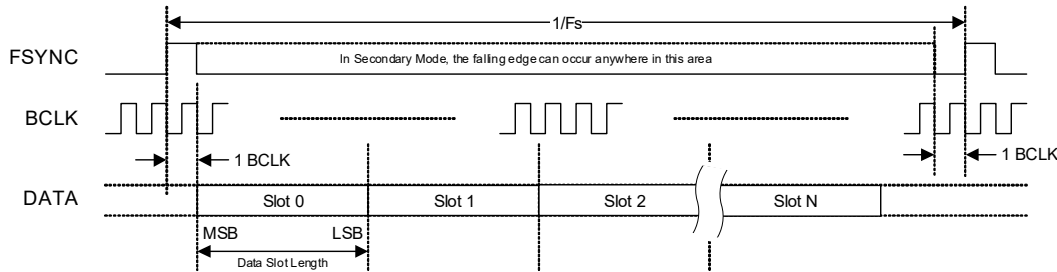

Figure 4-9. TDM Data Format

4.7.3 ASP Configuration

In hardware control mode, the ASP data format is determined by the CONFIG1 and CONFIG2 pins (see Section 4.2).

In software control mode, the ASP data format is configured using `SAMPLE_RATE` and `ASP_FORMAT`. If ASP Primary Mode is selected (see Section 4.7.1), the BCLK frequency is configured using `ASP_BCLK_FREQ`.

In software control mode, the BCLK polarity is selected using `ASP_BCLK_INV`. The polarity selection is valid in primary and secondary modes, and determines whether the data is valid for sampling on the rising edge or the falling edge.

The BCLK polarity is illustrated in Fig. 4-10 and Fig. 4-11. Note that, in hardware control mode, the BCLK polarity is assumed to be noninverted.

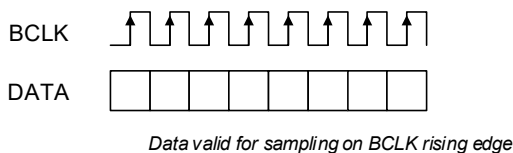

Figure 4-10. Noninverted BCLK

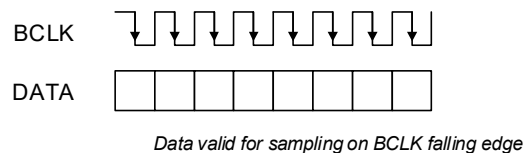

Figure 4-11. Inverted BCLK

In TDM Mode, the two data-format options are supported as follows:

- TDM Mode—minimum time slots. The ASP data format is configured to support the minimum number of time slots necessary for the 8-channel CS4308P output. This mode allows the BCLK rate to be as low as possible, equating to a minimum of 32 BCLK cycles per audio sample.
- TDM Mode—maximum time slots. The ASP data format is configured to support the maximum number of time slots for the applicable BCLK rate. The mode is designed for the maximum BCLK rate (22.5792 MHz for 44.1 kHz-related sample rates, or 24.576 MHz for 48 kHz-related sample rates), enabling the maximum possible bandwidth on the ASP data bus to be shared with other devices.

Note that, for sample rates >48 kHz, the TDM data format is the same regardless of the minimum/maximum time-slot option.

The ASP configuration depends on the sample rate and the selected data format as described in [Table 4-14](#). The output data is provided on one or more ASP_DINx pins, depending on the selected data format.

Table 4-14. ASP Data Format

ASP Format ¹	ASP Sample Rate ^{2,3}	DIN pins used	Time slots per frame ⁴	BCLK ^{5,6}
I ² S, Left-Justified	32 kHz	4	2	BCLK ≥ 64 fs ^[7]
	44.1 kHz, 48 kHz	4	2	BCLK ≥ 64 fs
	88.2 kHz, 96 kHz	4	2	BCLK ≥ 64 fs
	176.4 kHz, 192 kHz	4	2	BCLK ≥ 64 fs
	352.8 kHz, 384 kHz	4	2	BCLK = 64 fs
	705.6 kHz, 768 kHz	—	—	—
	Autodetect (32 kHz–192 kHz)	4	2	BCLK ≥ 64 fs
TDM—minimum time slots	32 kHz	1	8	BCLK ≥ 256 fs ^[7]
	44.1 kHz, 48 kHz	1	8	BCLK ≥ 256 fs
	88.2 kHz, 96 kHz	1	8	BCLK = 256 fs
	176.4 kHz, 192 kHz	2	4	BCLK = 128 fs
	352.8 kHz, 384 kHz	4	2	BCLK = 64 fs
	705.6 kHz, 768 kHz	—	—	—
	Autodetect (32 kHz–192 kHz)	2	4	BCLK ≥ 128 fs
TDM—maximum time slots	32 kHz	1	16	BCLK ≥ 512 fs ^[7]
	44.1 kHz, 48 kHz	1	16	BCLK = 512 fs
	88.2 kHz, 96 kHz	1	8	BCLK = 256 fs
	176.4 kHz, 192 kHz	2	4	BCLK = 128 fs
	352.8 kHz, 384 kHz	4	2	BCLK = 64 fs
	705.6 kHz, 768 kHz	—	—	—
	Autodetect (32 kHz–192 kHz)	2	4	BCLK ≥ 128 fs

- The ASP format is selected using the CONFIG2 pin (in hardware control mode) or [ASP_FORMAT](#) (in software control mode).
- The sample rate is selected using the CONFIG1 pin (in hardware control mode) or [SAMPLE_RATE](#) (in software control mode).
- Sample rates 32 kHz–384 kHz supported in software control mode, 32 kHz–192 kHz in hardware control mode.
- Time slots per frame is the number of data-sample time slots supported on each of the active DIN pins.
- The BCLK rate must be a constant integer multiple of the sample rate (fs).
- In ASP primary mode (hardware control), the BCLK frequency is the minimum specified rate. In ASP primary mode (software control), the BCLK frequency is configured using [ASP_BCLK_FREQ](#).
- In ASP primary mode, the specified minimum BCLK frequency for 32 kHz sample rate is not supported. The available options correspond to 96 fs, 192 fs, 384 fs, or 768 fs.

The ASP data format in I²S, Left-Justified, and TDM interface modes as illustrated in Fig. 4-12 through Fig. 4-16. Refer to Table 4-14 for the applicable definition.

- If I²S data format is selected, the ASP supports audio channels 1–8 as shown in Fig. 4-12. The minimum BCLK rate is 64 fs (where fs is the sample rate). A higher BCLK frequency can be used, resulting in unused BCLK cycles between the LSB of one sample and the MSB of the next.

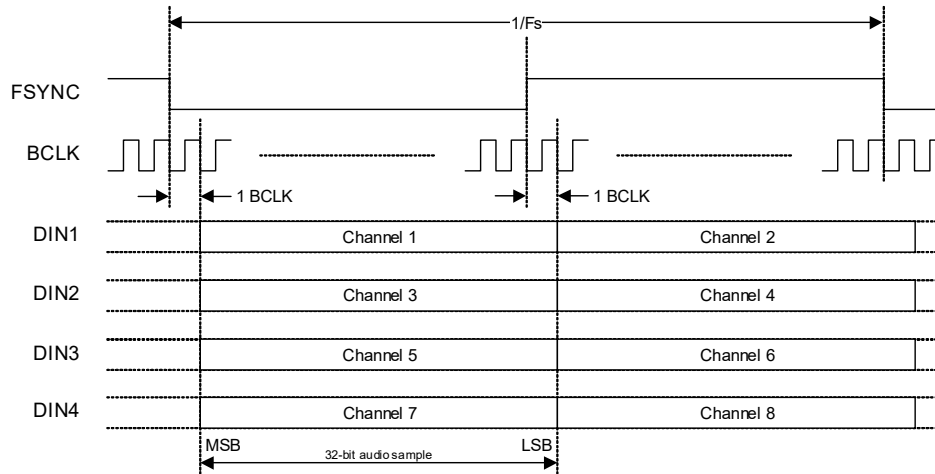

Figure 4-12. I²S Data Format

- If Left-Justified data format is selected, the ASP supports audio channels 1–8 as shown in Fig. 4-13. The minimum BCLK rate is 64 fs (where fs is the sample rate). A higher BCLK frequency can be used, resulting in unused BCLK cycles between the LSB of one sample and the MSB of the next.

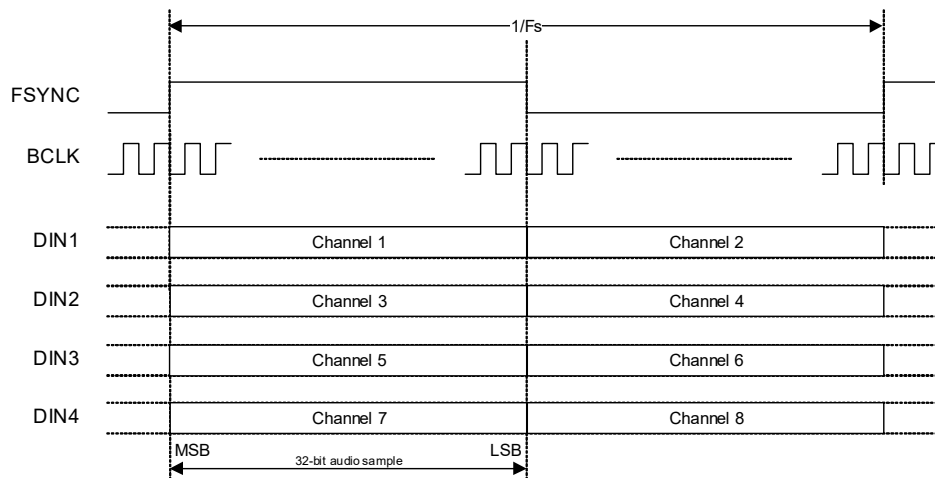

Figure 4-13. Left-Justified Data Format

- In TDM Mode, the FSYNC frame is configured for 2, 4, 8, or 16 slots as specified in Table 4-14. In 16-slot mode, the slot assignment for audio channels 1–8 is selected using the CONFIG3 pin (in hardware control mode—see Section 4.2) or else using ASP_TDM_SLOT (in software control mode). In 2-, 4-, and 8-slot modes, the default slot assignment (slots 0–7) should be selected. The BCLK rate is related to the sample rate (fs) as described in Table 4-14. Where applicable, the BCLK rate can be higher than the stated minimum, resulting in additional unused BCLK cycles between the last slot in the frame and the start of the next frame.

In 8- and 16-slot modes, the input data is provided on ASP_DIN1; the ASP_DIN2, ASP_DIN3, and ASP_DIN4 pins are not used.

The 8-slot TDM format is shown in Fig. 4-14. In 8-slot TDM format, audio channels 1–8 occupy TDM slots 0–7 respectively.

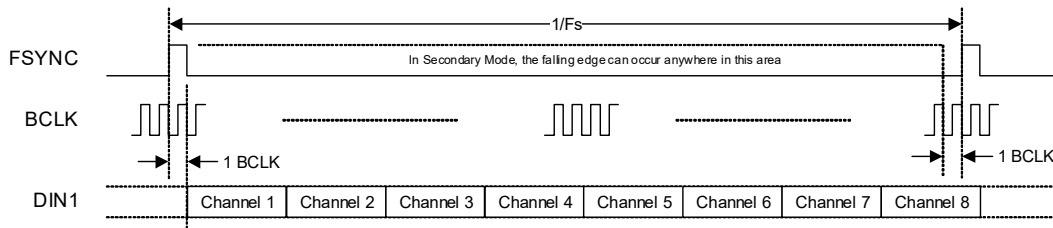

Figure 4-14. TDM Data Format—1 x DIN

In 4-slot mode, the input data is provided on ASP_DIN1 and ASP_DIN2.

The 4-slot TDM format is shown in Fig. 4-15.

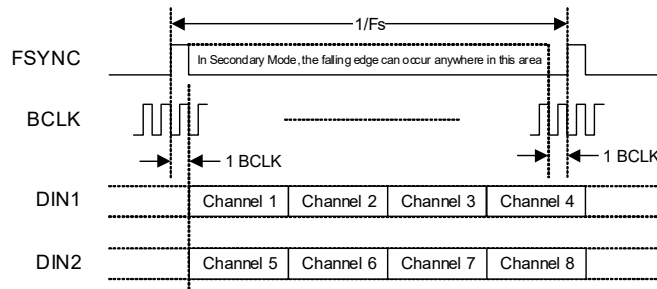

Figure 4-15. TDM Data Format—2 x DIN

In 2-slot mode, the input data is provided on ASP_DIN1, ASP_DIN2, ASP_DIN3, and ASP_DIN4. Note the 2-slot format is used to support 352.8 kHz and 384 kHz sample rates only.

The 2-slot TDM format is shown in Fig. 4-16.

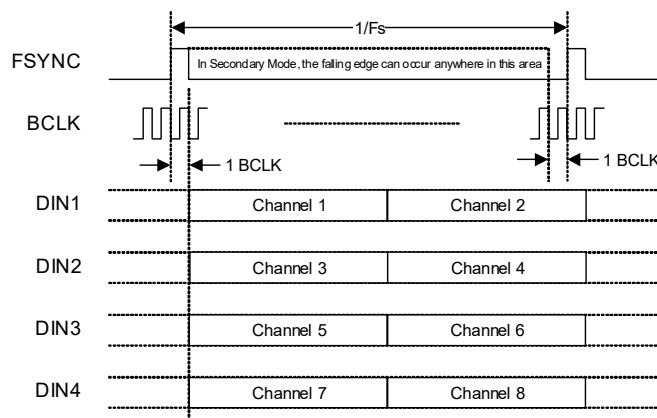

Figure 4-16. TDM Data Format—4 x DIN

4.7.4 Output Channel Summing

The DAC signal paths can be combined as described in Section 4.5.3; this can be used to achieve enhanced performance on the respective paths. If the DAC paths are combined, the ASP data format is redefined as a 4-, 2-, or 1-channel output.

If the output channels are combined to support 6-channel input, the ASP configuration depends on the sample rate and the selected data format as described in [Table 4-15](#). The input data is provided on one or more ASP_DINx pins, depending on the selected data format.

Table 4-15. ASP Data Format—6-channel

ASP Format ¹	ASP Sample Rate ²	DIN pins used	Time slots per frame ³	BCLK ^{4,5}
I ² S, Left-Justified	32 kHz	3	2	BCLK ≥ 64 fs ^[6]
	44.1 kHz, 48 kHz	3	2	BCLK ≥ 64 fs
	88.2 kHz, 96 kHz	3	2	BCLK ≥ 64 fs
	176.4 kHz, 192 kHz	3	2	BCLK ≥ 64 fs
	352.8 kHz, 384 kHz	3	2	BCLK = 64 fs
	705.6 kHz, 768 kHz	—	—	—
	Autodetect (32 kHz–192 kHz)	3	2	BCLK ≥ 64 fs
TDM—minimum time slots	32 kHz	1	8	BCLK ≥ 256 fs ^[6]
	44.1 kHz, 48 kHz	1	8	BCLK ≥ 256 fs
	88.2 kHz, 96 kHz	1	8	BCLK = 256 fs
	176.4 kHz, 192 kHz	2	4	BCLK = 128 fs
	352.8 kHz, 384 kHz	3	2	BCLK = 64 fs
	705.6 kHz, 768 kHz	—	—	—
	Autodetect (32 kHz–192 kHz)	2	4	BCLK ≥ 128 fs
TDM—maximum time slots	32 kHz	1	16	BCLK ≥ 512 fs ^[6]
	44.1 kHz, 48 kHz	1	16	BCLK = 512 fs
	88.2 kHz, 96 kHz	1	8	BCLK = 256 fs
	176.4 kHz, 192 kHz	2	4	BCLK = 128 fs
	352.8 kHz, 384 kHz	3	2	BCLK = 64 fs
	705.6 kHz, 768 kHz	—	—	—
	Autodetect (32 kHz–192 kHz)	2	4	BCLK ≥ 128 fs

1. The ASP format is selected using [ASP_FORMAT](#).
2. The sample rate is selected using [SAMPLE_RATE](#).
3. Time slots per frame is the number of data-sample time slots supported on each of the active DIN pins.
4. The BCLK rate must be a constant integer multiple of the sample rate (fs).
5. fs = sample rate. In ASP primary mode, the BCLK frequency is configured using [ASP_BCLK_FREQ](#).
6. In ASP primary mode, the specified minimum BCLK frequency for 32 kHz sample rate is not supported. The available options correspond to 96 fs, 192 fs, 384 fs, or 768 fs.

The 6-channel ASP format is illustrated in [Fig. 4-17](#) through [Fig. 4-21](#).

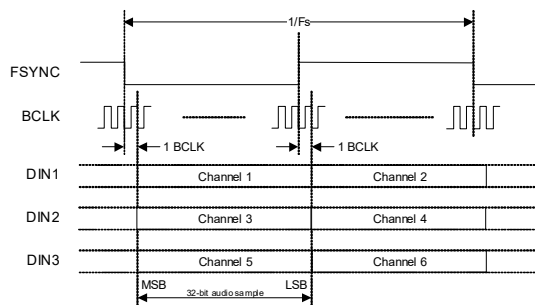
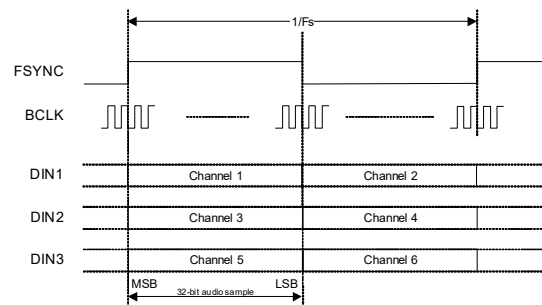
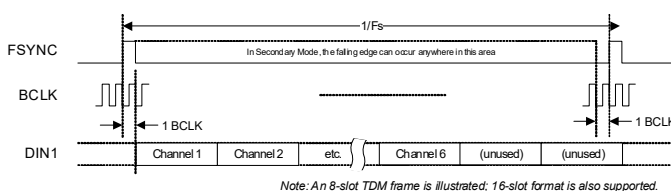
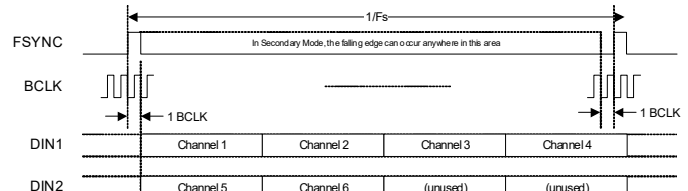
Figure 4-17. I²S Data Format

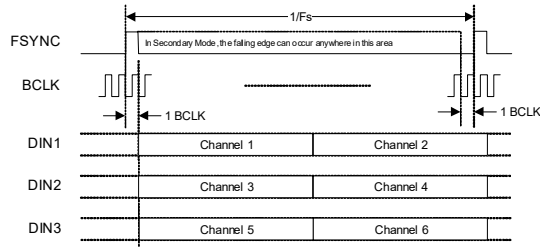
Figure 4-18. Left-Justified Data Format

Figure 4-19. TDM Data Format—1 x DIN

Figure 4-20. TDM Data Format—2 x DIN

Figure 4-21. TDM Data Format—3 x DIN

If the output channels are combined in groups of two, the CS4308P supports a 4-channel input. The ASP configuration depends on the sample rate and the selected data format as described in [Table 4-16](#). The input data is provided on one or more ASP_DINx pins, depending on the selected data format.

Table 4-16. ASP Data Format—4-channel

ASP Format 1	ASP Sample Rate 2	DIN pins used	Time slots per frame 3	BCLK 4,5
I2S, Left-Justified	32 kHz	2	2	BCLK ≥ 64 fs [6]
	44.1 kHz, 48 kHz	2	2	BCLK ≥ 64 fs
	88.2 kHz, 96 kHz	2	2	BCLK ≥ 64 fs
	176.4 kHz, 192 kHz	2	2	BCLK ≥ 64 fs
	352.8 kHz, 384 kHz	2	2	BCLK = 64 fs
	705.6 kHz, 768 kHz	—	—	—
	Autodetect (32 kHz–192 kHz)	2	2	BCLK ≥ 64 fs
TDM—minimum time slots	32 kHz	1	4	BCLK ≥ 128 fs [6]
	44.1 kHz, 48 kHz	1	4	BCLK ≥ 128 fs
	88.2 kHz, 96 kHz	1	4	BCLK ≥ 128 fs
	176.4 kHz, 192 kHz	1	4	BCLK = 128 fs
	352.8 kHz, 384 kHz	2	2	BCLK = 64 fs
	705.6 kHz, 768 kHz	4	1	BCLK = 32 fs
	Autodetect (32 kHz–192 kHz)	1	4	BCLK ≥ 128 fs
TDM—maximum time slots	32 kHz	1	16	BCLK ≥ 512 fs [6]
	44.1 kHz, 48 kHz	1	16	BCLK = 512 fs
	88.2 kHz, 96 kHz	1	8	BCLK = 256 fs
	176.4 kHz, 192 kHz	1	4	BCLK = 128 fs
	352.8 kHz, 384 kHz	2	2	BCLK = 64 fs
	705.6 kHz, 768 kHz	4	1	BCLK = 32 fs
	Autodetect (32 kHz–192 kHz)	1	4	BCLK ≥ 128 fs

1. The ASP format is selected using [ASP_FORMAT](#).
2. The sample rate is selected using [SAMPLE_RATE](#).
3. Time slots per frame is the number of data-sample time slots supported on each of the active DIN pins.
4. The BCLK rate must be a constant integer multiple of the sample rate (fs).
5. fs = sample rate. In ASP primary mode, the BCLK frequency is configured using [ASP_BCLK_FREQ](#).
6. In ASP primary mode, the specified minimum BCLK frequency for 32 kHz sample rate is not supported. The available options correspond to 96 fs, 192 fs, 384 fs, or 768 fs.

The 4-channel ASP format is illustrated in [Fig. 4-22](#) through [Fig. 4-26](#).

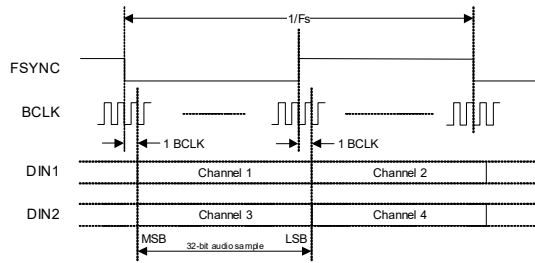

Figure 4-22. I2S Data Format

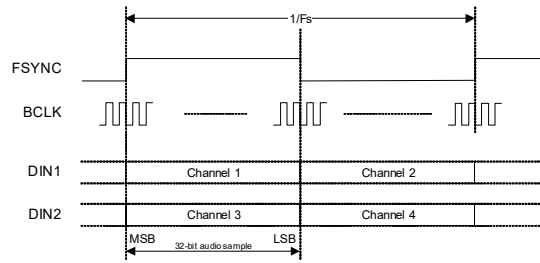

Figure 4-23. Left-Justified Data Format

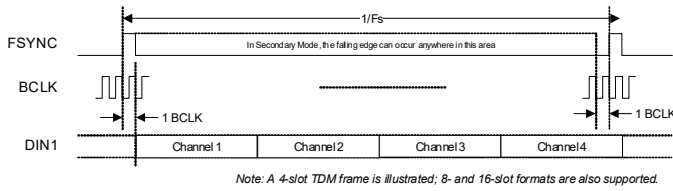

Figure 4-24. TDM Data Format—1 x DIN

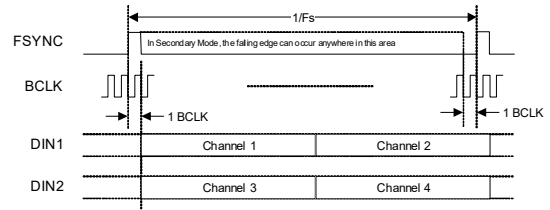

Figure 4-25. TDM Data Format—2 x DIN

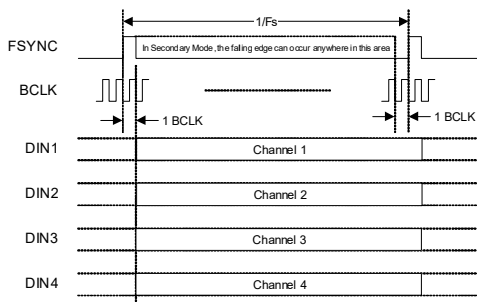

Figure 4-26. TDM Data Format—4 x DIN

If the output channels are combined in groups of four, the CS4308P supports a 2-channel input. The ASP configuration depends on the sample rate and the selected data format as described in [Table 4-17](#). The input data is provided on ASP_DIN1 in most cases; the ASP_DIN2 pin is used for 705.6 kHz/768 kHz operation only.

Table 4-17. ASP Data Format—2-channel

ASP Format ¹	ASP Sample Rate ²	DIN pins used	Time slots per frame ³	BCLK ^{4,5}
I ² S, Left-Justified	32 kHz	1	2	BCLK ≥ 64 fs ^[6]
	44.1 kHz, 48 kHz	1	2	BCLK ≥ 64 fs
	88.2 kHz, 96 kHz	1	2	BCLK ≥ 64 fs
	176.4 kHz, 192 kHz	1	2	BCLK ≥ 64 fs
	352.8 kHz, 384 kHz	1	2	BCLK = 64 fs
	705.6 kHz, 768 kHz	—	—	—
	Autodetect (32 kHz–192 kHz)	1	2	BCLK ≥ 64 fs
TDM—minimum time slots	32 kHz	1	2	BCLK ≥ 64 fs ^[6]
	44.1 kHz, 48 kHz	1	2	BCLK ≥ 64 fs
	88.2 kHz, 96 kHz	1	2	BCLK ≥ 64 fs
	176.4 kHz, 192 kHz	1	2	BCLK ≥ 64 fs
	352.8 kHz, 384 kHz	1	2	BCLK = 64 fs
	705.6 kHz, 768 kHz	2	1	BCLK = 32 fs
	Autodetect (32 kHz–192 kHz)	1	2	BCLK ≥ 64 fs
TDM—maximum time slots	32 kHz	1	16	BCLK ≥ 512 fs ^[6]
	44.1 kHz, 48 kHz	1	16	BCLK = 512 fs
	88.2 kHz, 96 kHz	1	8	BCLK = 256 fs
	176.4 kHz, 192 kHz	1	4	BCLK = 128 fs
	352.8 kHz, 384 kHz	1	2	BCLK = 64 fs
	705.6 kHz, 768 kHz	2	1	BCLK = 32 fs
	Autodetect (32 kHz–192 kHz)	1	4	BCLK ≥ 128 fs

1. The ASP format is selected using [ASP_FORMAT](#).
2. The sample rate is selected using [SAMPLE_RATE](#).
3. Time slots per frame is the number of data-sample time slots supported on each of the active DIN pins.
4. The BCLK rate must be a constant integer multiple of the sample rate (fs).
5. fs = sample rate. In ASP primary mode, the BCLK frequency is configured using [ASP_BCLK_FREQ](#).
6. In ASP primary mode, the specified minimum BCLK frequency for 32 kHz sample rate is not supported. The available options correspond to 96 fs, 192 fs, 384 fs, or 768 fs.

The 2-channel ASP format is illustrated in [Fig. 4-27](#) through [Fig. 4-30](#).

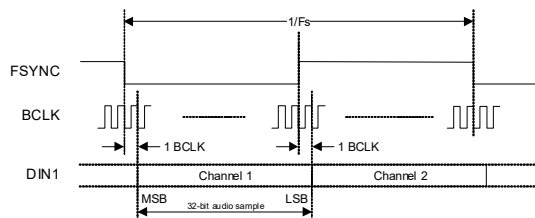
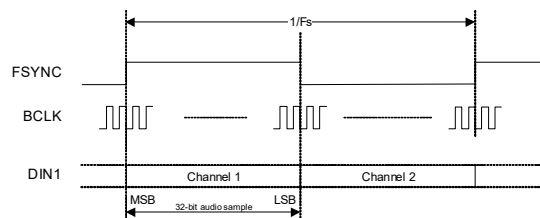
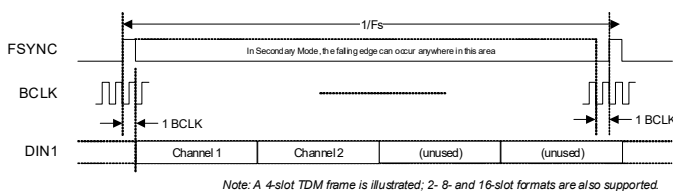
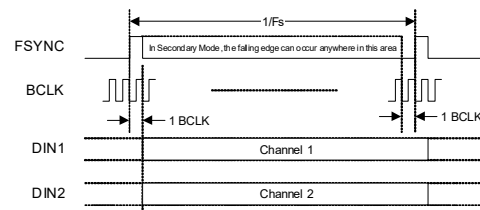
Figure 4-27. I²S Data Format

Figure 4-28. Left-Justified Data Format

Figure 4-29. TDM Data Format—1 x DIN

Figure 4-30. TDM Data Format—2 x DIN

If the output channels are combined in a group of eight, the CS4308P supports a 1-channel input. The ASP configuration depends on the sample rate and the selected data format as described in [Table 4-18](#). The input data is provided on ASP_DIN1; the ASP_DIN2, ASP_DIN3 and ASP_DIN4 pins are not used.

Table 4-18. ASP Data Format—1-channel

ASP Format ¹	ASP Sample Rate ²	DIN pins used	Time slots per frame ³	BCLK ^{4,5}
I ² S, Left-Justified	32 kHz	1	2	BCLK ≥ 64 fs ^[6]
	44.1 kHz, 48 kHz	1	2	BCLK ≥ 64 fs
	88.2 kHz, 96 kHz	1	2	BCLK ≥ 64 fs
	176.4 kHz, 192 kHz	1	2	BCLK ≥ 64 fs
	352.8 kHz, 384 kHz	1	2	BCLK = 64 fs
	705.6 kHz, 768 kHz	—	—	—
	Autodetect (32 kHz–192 kHz)	1	2	BCLK ≥ 64 fs
TDM—minimum time slots	32 kHz	1	1	BCLK ≥ 64 fs ^[6]
	44.1 kHz, 48 kHz	1	1	BCLK ≥ 64 fs
	88.2 kHz, 96 kHz	1	1	BCLK ≥ 32 fs
	176.4 kHz, 192 kHz	1	1	BCLK ≥ 32 fs
	352.8 kHz, 384 kHz	1	1	BCLK ≥ 32 fs
	705.6 kHz, 768 kHz	1	1	BCLK = 32 fs
	Autodetect (32 kHz–192 kHz)	1	1	BCLK ≥ 64 fs
TDM—maximum time slots	32 kHz	1	16	BCLK ≥ 512 fs ^[6]
	44.1 kHz, 48 kHz	1	16	BCLK = 512 fs
	88.2 kHz, 96 kHz	1	8	BCLK = 256 fs
	176.4 kHz, 192 kHz	1	4	BCLK = 128 fs
	352.8 kHz, 384 kHz	1	2	BCLK = 64 fs
	705.6 kHz, 768 kHz	1	1	BCLK = 32 fs
	Autodetect (32 kHz–192 kHz)	1	4	BCLK ≥ 128 fs

- The ASP format is selected using [ASP_FORMAT](#) (in software control mode).
- The sample rate is selected using [SAMPLE_RATE](#) (in software control mode).
- Time slots per frame is the number of data-sample time slots supported on each of the active DIN pins.
- The BCLK rate must be a constant integer multiple of the sample rate (fs).
- fs = sample rate. In ASP primary mode, the BCLK frequency is configured using [ASP_BCLK_FREQ](#).
- In ASP primary mode, the specified minimum BCLK frequency for 32 kHz sample rate is not supported. The available options correspond to 96 fs, 192 fs, 384 fs, or 768 fs.

The 1-channel ASP format is illustrated in [Fig. 4-31](#) through [Fig. 4-33](#).

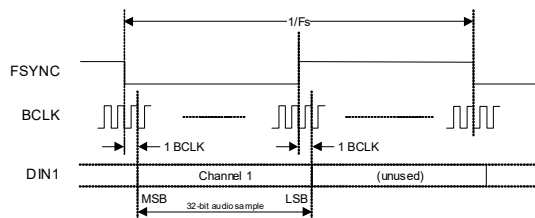
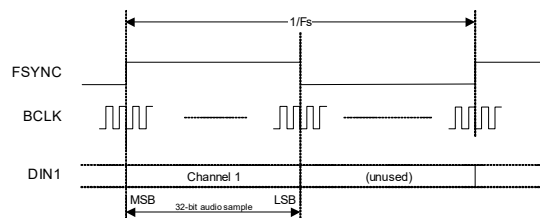
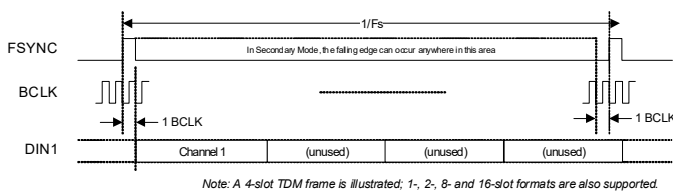
Figure 4-31. I²S Data Format

Figure 4-32. Left-Justified Data Format

Figure 4-33. TDM Data Format

4.7.5 ASP Channel Reverse Order

The CS4308P supports an option to reverse the ASP channel order. If the reverse channel order is selected, the ASP data format is reconfigured to map the input channels in the opposite order to the default order shown in [Section 4.7.3](#) and [Section 4.7.4](#).

Note: The ASP reverse channel-order option is not supported in 6-channel summing configuration.

The reverse channel-order option can be used to ease PCB layout constraints, enabling the ASP data ordering to be aligned with the external pin connections, regardless of the orientation of the device on the PCB.

The reverse channel order is illustrated in [Fig. 4-34](#) and [Fig. 4-35](#). The I²S data format is shown as an example; the equivalent channel substitutions are supported in left-justified and TDM format also.

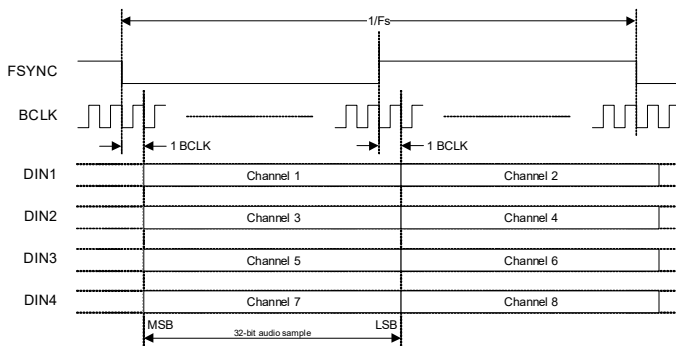

Figure 4-34. Default Channel Order

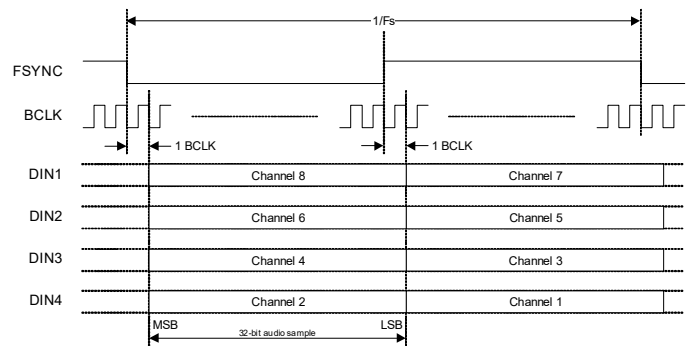

Figure 4-35. Reverse Channel Order

In hardware control mode, the ASP channel order is selected using the CONFIG4 hardware control pin, as described in [Section 4.2](#). In software (I²C/SPI) control mode, the ASP channel order is selected using [ASP_CH_REVERSE](#).

4.8 DSD Interface

Direct Stream Digital (DSD) is a high-resolution audio-coding standard that employs 1-bit sampling at high oversample rates. The DSD interface uses noise shaping and other filters to decode the data for the purposes of analog audio playback. The CS4308P supports a six-channel DSD interface.

The DSD interface supports digital input at oversample rates up to 512×fs. Phase modulation of the digital input is also supported at 64×fs oversample rate. A selectable high-pass filter is provided in the DSD signal path.

The DSD clock input (DSD_CLK) can be used as the system-clock reference for the CS4308P. See [Section 4.4](#) for further details.

Note the DSD interface is supported in software control mode only.

4.8.1 DSD Enable

The DSD interface is enabled using DSD_EN. Note that the ASP interface (see [Section 4.7](#)) is disabled if the DSD interface is enabled.

The DSD interface supports six-channel input using the respective DSD_DINx data pins. The timing of the DSD data is supported using the DSD_CLK clock input. The DSD interface connections are illustrated in Fig. 4-36.

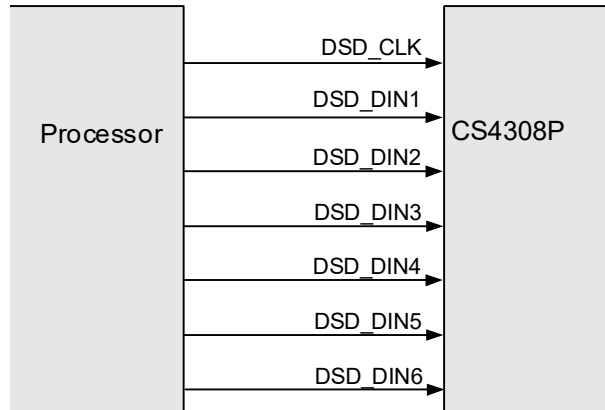

Figure 4-36. DSD Interface Connection

4.8.2 DSD Format

The DSD interface format is shown in Fig. 4-37. In this default configuration, a new data bit is received on each falling CLK edge, for sampling at the next rising edge. See Table 3-12 for timing specifications.

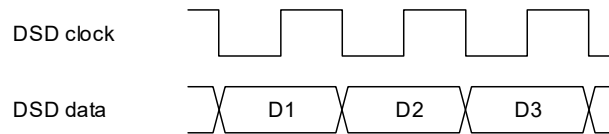

Figure 4-37. DSD Interface Timing

The oversample rate is configured using [DSD_OS](#). This field must be configured to match the DSD input stream. Oversample rates 64×fs, 128×fs, 256×fs, and 512×fs rates are supported (where fs = 44.1 kHz).

The CS4308P supports DSD phase modulation, where the DSD data is represented in *data plus data-inverted* format as shown in Fig. 4-38. Phase modulation is configured by setting [DSD_PM_EN](#). Note that phase modulation supported for 64×fs data rate only.

If phase modulation is enabled, the DSD clock rate is configured using [DSD_PM_SEL](#). By default, the clock rate is 128×fs (i.e., 2 x OSR rate). The clock rate can be adjusted to 64×fs if required.

The phase-modulation data formats are shown in Fig. 4-38 and Fig. 4-39.

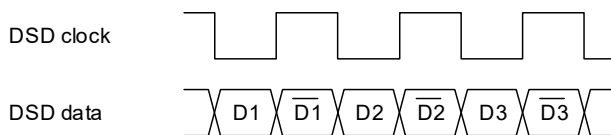

Figure 4-38. DSD Phase Modulation—64fs CLK

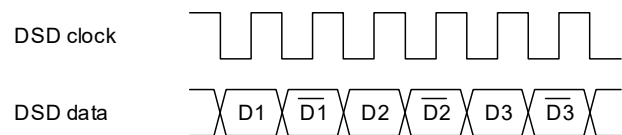

Figure 4-39. DSD Phase Modulation—128fs CLK

4.8.3 Signal Level Control

The scaling of the DSD signal level, relative to the full-scale level of the CS4308P DAC output path, is configurable using [DSD_ZEROdB](#). The scaling is defined with reference to the SACD standard for DSD signal levels.

4.8.4 High-Pass Filter

A high-pass filter is incorporated in the DSD signal path. The filter is selected using [DSD_HPF_EN](#). The filter is enabled by default.

Note the digital filters described in [Section 4.6](#) are not supported on the DSD path.

4.9 I²C/SPI Control Port

The CS4308P incorporates a control port, supporting I²C or SPI modes of operation. In software control mode, the CS4308P is configured by writing to control registers using the control port.

The control port is automatically configured in I²C mode or SPI mode following the first valid I²C/SPI activity detected after power-on or hardware reset.

4.9.1 I²C Control Port

The I²C control port is supported using the I2C_SCL and I2C_SDA pins.

The CS4308P is a target device on the I²C bus—SCL is a clock input, while SDA is a bidirectional data pin. To allow arbitration of multiple targets (and/or multiple controllers) on the same interface, the CS4308P transmits Logic 1 by tristating the SDA pin, rather than pulling it high. An external pull-up resistor is required to pull the SDA line high so that the Logic 1 can be recognized by the controller.

In order to allow many devices to share a single two-wire control bus, every device on the bus has a unique 8-bit device address (this is not the same as the address of each register in the CS4308P). Note that the LSB of the device address is the read/write bit; this bit is set to Logic 1 for read and Logic 0 for write.

The I²C device address is configured using the CONFIG5 pin as described in [Table 4-19](#).

Table 4-19. I²C Address Selection—CONFIG5 pin

Pin Configuration		I ² C Address
Pull-up to VDD_A	0 Ω	0x6E (write), 0x6F (read)
	4.7 kΩ	0x6C (write), 0x6D (read)
	22 kΩ	0x6A (write), 0x6B (read)
	100 kΩ	0x68 (write), 0x69 (read)
Pull-down to GND_A	100 kΩ	0x66 (write), 0x67 (read)
	22 kΩ	0x64 (write), 0x65 (read)
	4.7 kΩ	0x62 (write), 0x63 (read)
	0 Ω	0x60 (write), 0x61 (read)

The host device indicates the start of data transfer with a high-to-low transition on SDA while SCL remains high. This indicates that a device address and subsequent address/data bytes follow. The CS4308P responds to the start condition and shifts in the next 8 bits on SDA (8-bit device address, including read/write bit, MSB first). If the device address received matches the device address of the CS4308P, the CS4308P responds by pulling SDA low on the next clock pulse (ACK). If the device address is not recognized or the R/W bit is set incorrectly, the CS4308P returns to the idle condition and waits for a new start condition.

If the device address matches the device address of the CS4308P, the data transfer continues. The controller indicates the end of data transfer with a low-to-high transition on SDA while SCL remains high. After receiving a complete address and data sequence the CS4308P returns to the idle state and waits for another start condition. If a start or stop condition is detected out of sequence at any point during data transfer (i.e., SDA changes while SCL is high), the device returns to the idle condition.

The I²C interface uses a 16-bit register address and 16-bit data words. The register address must be aligned to a 16-bit word boundary (i.e., the LSB must be 0). Note that the full I²C message protocol also includes a device address, a read/write bit, and other signaling bits (see [Fig. 4-40](#) and [Fig. 4-41](#)).

The CS4308P supports the following read and write operations:

- Single write
- Single read
- Multiple write
- Multiple read

Continuous (multiple) read and write modes allow register operations to be scheduled faster than is possible with single register operations. In these modes, the CS4308P automatically increments the register address after each data word. Successive data words can be input/output every two data bytes.

The I²C protocol for a single, 16-bit register write operation is shown in Fig. 4-40.

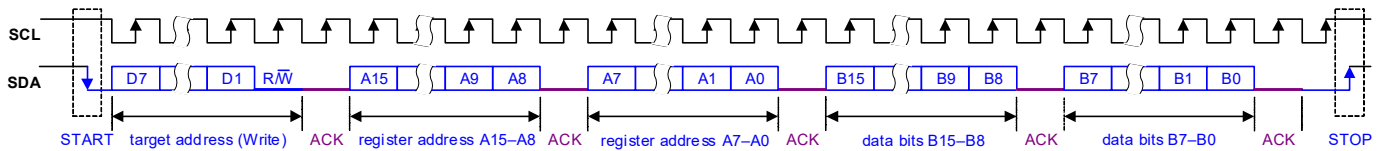

Note: The SDA pin is used as input for the control register address and data; SDA is pulled low by the receiving device to provide the acknowledge (ACK) response

Figure 4-40. Control Interface I²C Register Write

The I²C protocol for a single, 16-bit register read operation is shown in Fig. 4-41.

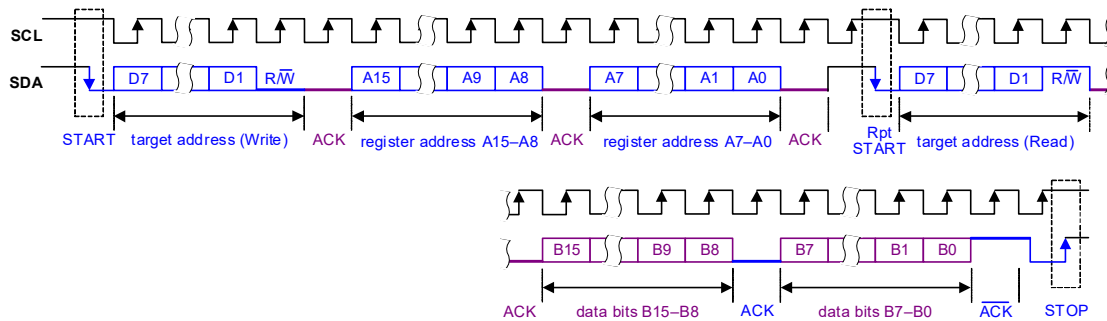

Note: The SDA pin is driven by both the controller and target devices in turn to transfer target address, register address, data and ACK response

Figure 4-41. Control Interface I²C Register Read

The control interface also supports other register operations; the interface protocol for these operations is shown in Fig. 4-42 through Fig. 4-45. The terminology used in the following figures is detailed in Table 4-20.

Table 4-20. Control Interface (I²C) Terminology

Terminology	Description
S	Start condition
Sr	Repeated start
A	Acknowledge (SDA low)
\bar{A}	No Acknowledge (SDA high)
P	Stop condition
R/W	Read/not Write: 0 = Write, 1 = Read
[White field]	Data flow from bus controller to CS4308P
[Gray field]	Data from CS4308P to bus controller

Fig. 4-42 shows a single register write to a specified address.

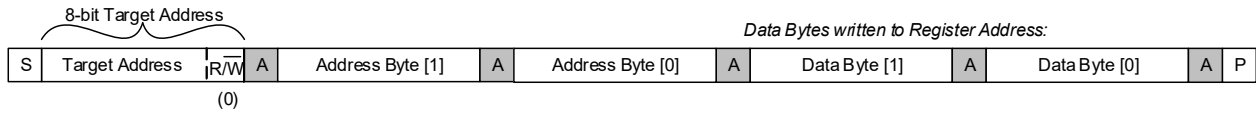

Figure 4-42. Single-Register Write to Specified Address

Fig. 4-43 shows a single register read from a specified address.

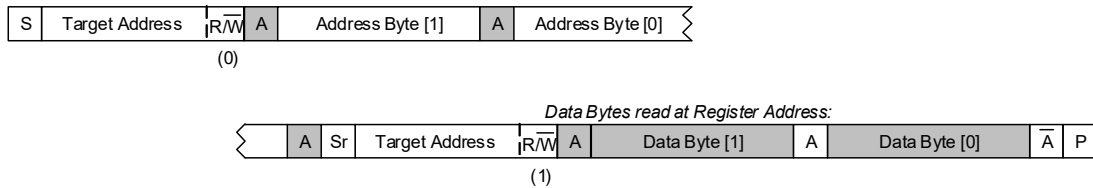

Figure 4-43. Single-Register Read from Specified Address

Fig. 4-44 shows a multiple register write to a specified address.

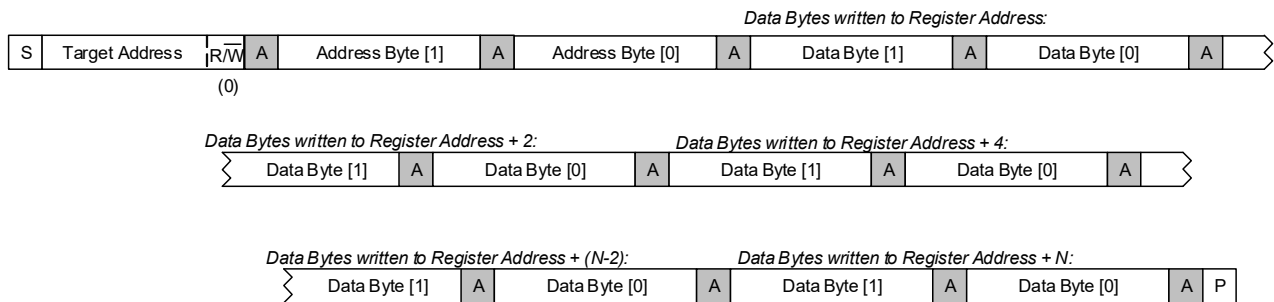

Figure 4-44. Multiple-Register Write to Specified Address

Fig. 4-45 shows a multiple register read from a specified address.

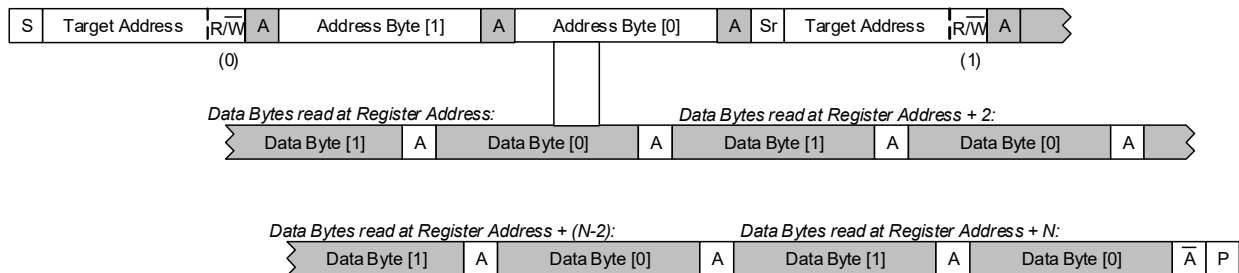

Figure 4-45. Multiple-Register Read from Specified Address

4.9.2 SPI Interface

The SPI interface is supported using the $\overline{\text{SPI_CS}}$, SPI_SCK, SPI_SDI, and SPI_SDO pins.

The SDI (data-input) pin supports the following behavior:

- In write operations ($\overline{\text{R/W}} = 0$), the SDI pin input is driven by the controlling device.
- In read operations ($\overline{\text{R/W}} = 1$), the SDI pin is ignored following receipt of the valid register address.

The SDO (data-output) pin supports the following behavior:

- If \overline{CS} is asserted (Logic 0), the SDO output is actively driven when outputting data and is high impedance at other times. If \overline{CS} is not asserted, the SDO output is high impedance.
- The high-impedance state of the SDO output allows the pin to be shared with other peripheral devices.
- The output (SDO) data bit is available to the host device at the rising edge of SCK. See [Table 3-14](#) for timing information.

The SPI interface uses a 15-bit register address and 16-bit data words. Note that the full SPI message protocol also includes a read/write bit and a 16-bit padding phase (see [Fig. 4-46](#) and [Fig. 4-47](#)).

Continuous read and write modes enable multiple register operations to be scheduled faster than is possible with single register operations. In these modes, the CS4308P automatically increments the register address at the end of each data word, for as long as \overline{SS} is held low and SCK is toggled. Successive data words can be input/output every 16 clock cycles.

The SPI protocol is shown in [Fig. 4-46](#) and [Fig. 4-47](#).

[Fig. 4-46](#) shows a single register write to a specified address.

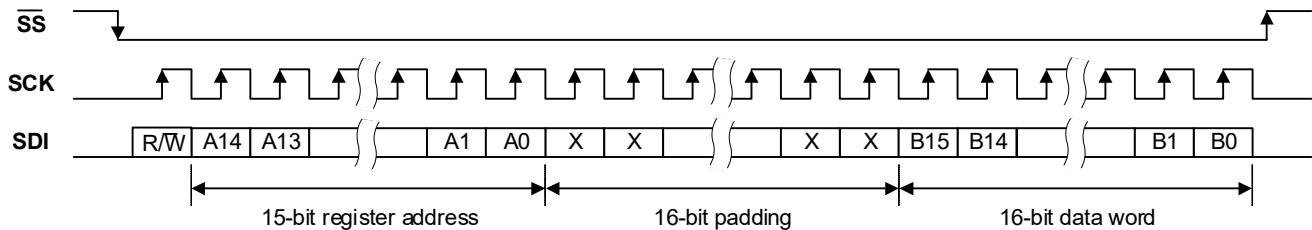

Figure 4-46. Control Interface SPI Register Write

[Fig. 4-47](#) shows a single register read from a specified address.

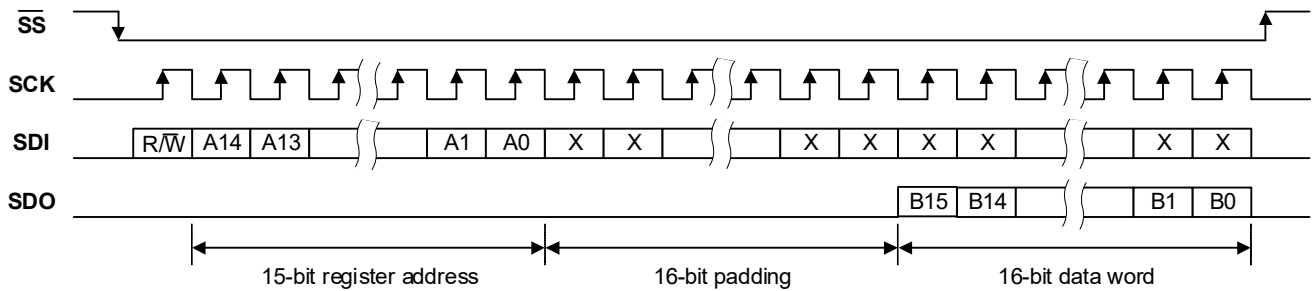

Figure 4-47. Control Interface SPI Register Read

[Fig. 4-48](#) shows a multiple register write to a specified address.

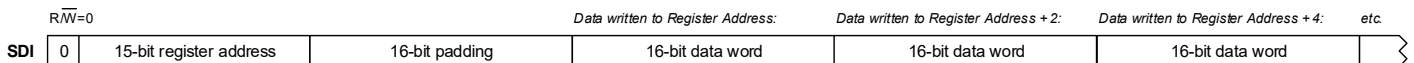

Figure 4-48. Multiple-Register Write to Specified Address

[Fig. 4-49](#) shows a multiple register read from a specified address.

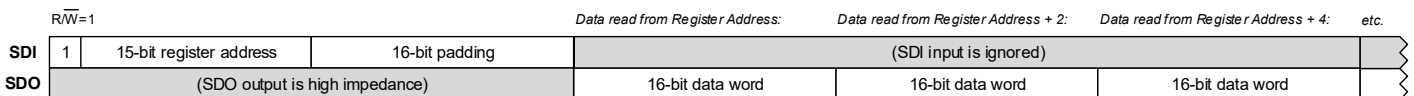

Figure 4-49. Multiple-Register Read from Specified Address

4.10 General-Purpose Output

The CS4308P supports general-purpose outputs on selected digital I/O pins. General-purpose (GP) outputs can be used to provide hardware control signals to other devices.

The general-purpose outputs are multiplexed with other pin functions (e.g., I²C/SPI control port, or the audio serial port). Note that care must be taken not to configure a pin for GP output if the shared pin function is required.

Each pin is configured for GP output by setting the respective `_FN` bit as noted in [Table 4-21](#). If a pin is configured for GP output, the logic output level is selected using the respective `_LVL` bit.

Table 4-21. General Purpose Output

Pin Name	Power Supply ¹	Pin Function Select	Output Level Select	Notes
CONFIG5	VDD_A	CONFIG5_FN	CONFIG5_LVL	GP output is not supported if the I2C control port (see Section 4.9.1) is used.
CONFIG4	VDD_A	CONFIG4_FN	CONFIG4_LVL	
CONFIG3	VDD_IO	CONFIG3_FN	CONFIG3_LVL	GP output is not supported if the DSD interface (see Section 4.8) is used.
CONFIG2	VDD_IO	CONFIG2_FN	CONFIG2_LVL	
SPI_SCK	VDD_IO	SPI_SCK_FN	SPI_SCK_LVL	GP output is not supported if the SPI control port (see Section 4.9.2) is used.
SPI_CS	VDD_IO	SPI_CS_FN	SPI_CS_LVL	
ASP_DIN4	VDD_IO	ASP_DIN4_FN	ASP_DIN4_LVL	Refer to Section 4.7 to determine which pins are required for ASP output, depending on the applicable data format. Unused pins can be configured for GP output.
ASP_DIN3	VDD_IO	ASP_DIN3_FN	ASP_DIN3_LVL	
ASP_DIN2	VDD_IO	ASP_DIN2_FN	ASP_DIN2_LVL	

1. The digital I/O logic levels for each pin are defined with respect to the applicable power supply. See [Table 3-8](#) for details.

4.11 Device ID

The device ID, and other associated data, can be read from the control fields listed in [Table 4-22](#).

Table 4-22. Device ID

Label	Description
DEVID	Device ID
AREVID	All-layer device revision
MTLREVID	Metal-layer device revision

5 Register Quick Reference

This section gives an overview of the control port registers. Refer to the following bit definition tables for bit assignment information.

This register view is for the CS4308P.

- The register field default values are established upon the deassertion of the $\overline{\text{RESET}}$ pin or following soft reset.
- A "—" represents a reserved field/access type.
- The reserved field values must not be modified.
- The registers are 16 bits wide, and only word transactions are allowed.
- All visible fields are read/write except where indicated with the following shading:

Read/write access
 Read-only access
 Write-only access

Table 5-1. Block Base Addresses

Base Address	Block Name	Register Quick Reference	Register Description Reference
0x0000 0000	DEVID	Section 5.1	Section 6.1
0x0000 0040	CONFIG	Section 5.2	Section 6.2
0x0000 00C0	OUTPUT_PATH	Section 5.3	Section 6.3
0x0000 3D00	PIN_CONFIG	Section 5.4	Section 6.4

5.1 DEVID

Address	Register	15	14	13	12	11	10	9	8	7	6	5	4	3	2	1	0
0x0000 0000 p. 48	DEVID	DEVID															
		0	1	0	0	0	0	1	1	0	0	0	0	1	0	0	0
0x0000 0004 p. 48	REVID	—								AREVID				MTLREVID			
		0	0	0	0	0	0	0	0	1	0	1	0	0	0	0	0
0x0000 0022 p. 48	SW_RESET	SW_RESET								—							
		0	0	0	0	0	0	0	0	0	0	0	0	0	0	0	0

5.2 CONFIG

Address	Register	15	14	13	12	11	10	9	8	7	6	5	4	3	2	1	0	
0x0000 0040 p. 49	CLK_CFG_0	—			SYSCLK_SRC	—						PLL_REFCLK_FREQ		—			PLL_REFCLK_SRC	
		0	0	0	1	0	0	0	0	0	0	1	1	0	0	0	0	
0x0000 0042 p. 49	CLK_CFG_1	—										SAMPLE_RATE						
		0	0	0	0	0	0	0	0	0	0	0	0	0	0	0	1	
0x0000 0044 p. 49	CHIP_ENABLE	—															GLOBAL_EN	
		0	0	0	0	0	0	0	0	0	0	0	0	0	0	0	0	
0x0000 0048 p. 50	ASP_CFG	—									ASP_BCLK_INV	ASP_PRIMARY	—			ASP_BCLK_FREQ		
		0	0	0	0	0	0	0	0	0	0	0	0	0	0	0	0	
0x0000 0050 p. 50	SIGNAL_PATH_CFG	—						ASP_CH_REVERSE	—				ASP_TDM_SLOT			ASP_FORMAT		
		0	0	0	0	0	0	0	0	0	0	0	0	0	0	0	0	

5.3 OUTPUT_PATH

Address	Register	15	14	13	12	11	10	9	8	7	6	5	4	3	2	1	0	
0x0000 00C0 p. 51	OUT_ENABLES	—								OUT8_DAC_EN	OUT7_DAC_EN	OUT6_DAC_EN	OUT5_DAC_EN	OUT4_DAC_EN	OUT3_DAC_EN	OUT2_DAC_EN	OUT1_DAC_EN	
		0	0	0	0	0	0	0	0	0	0	0	0	0	0	0	0	0
0x0000 00C2 p. 51	OUT_RAMP_SUM	OUT_SUM_MODE				—				OUT_RAMP_RATE_DEC			—	OUT_RAMP_RATE_INC				
		0	0	0	0	0	0	0	0	0	0	1	0	0	0	1	0	0
0x0000 00C4 p. 52	OUT_DEEMPH	—															OUT_DEEMPH_FILTER_SEL	OUT_DEEMPH_EN
		0	0	0	0	0	0	0	0	0	0	0	0	0	0	0	0	0
0x0000 00C6 p. 52	OUT_FILTER	—		OUT_HP_FEN		—		OUT_FILTER_SEL			—							
		0	0	0	0	0	0	0	0	0	0	0	0	0	0	0	0	0
0x0000 00CA p. 52	OUT_INV	—								OUT8_INV	OUT7_INV	OUT6_INV	OUT5_INV	OUT4_INV	OUT3_INV	OUT2_INV	OUT1_INV	
		0	0	0	0	0	0	0	0	0	0	0	0	0	0	0	0	0
0x0000 00D0 p. 53	OUT_VOL_CTRL1_0	OUT1_MUTE	—								OUT1_VOL							
		1	0	0	0	0	0	0	0	0	0	0	0	0	0	0	0	0
0x0000 00D2 p. 53	OUT_VOL_CTRL1_1	OUT2_MUTE	—								OUT2_VOL							
		1	0	0	0	0	0	0	0	0	0	0	0	0	0	0	0	0
0x0000 00D4 p. 54	OUT_VOL_CTRL2_0	OUT3_MUTE	—								OUT3_VOL							
		1	0	0	0	0	0	0	0	0	0	0	0	0	0	0	0	0
0x0000 00D6 p. 54	OUT_VOL_CTRL2_1	OUT4_MUTE	—								OUT4_VOL							
		1	0	0	0	0	0	0	0	0	0	0	0	0	0	0	0	0
0x0000 00D8 p. 54	OUT_VOL_CTRL3_0	OUT5_MUTE	—								OUT5_VOL							
		1	0	0	0	0	0	0	0	0	0	0	0	0	0	0	0	0
0x0000 00DA p. 54	OUT_VOL_CTRL3_1	OUT6_MUTE	—								OUT6_VOL							
		1	0	0	0	0	0	0	0	0	0	0	0	0	0	0	0	0
0x0000 00DC p. 55	OUT_VOL_CTRL4_0	OUT7_MUTE	—								OUT7_VOL							
		1	0	0	0	0	0	0	0	0	0	0	0	0	0	0	0	0
0x0000 00DE p. 55	OUT_VOL_CTRL4_1	OUT8_MUTE	—								OUT8_VOL							
		1	0	0	0	0	0	0	0	0	0	0	0	0	0	0	0	0
0x0000 00E0 p. 55	OUT_VOL_CTRL5	—															OUT_VU	
		0	0	0	0	0	0	0	0	0	0	0	0	0	0	0	0	0
0x0000 00E4 p. 55	SHUTDOWN_CTRL	—															DAC_REF_DISABLE	
		0	0	0	0	0	0	0	0	0	0	0	0	0	0	0	0	0
0x0000 00E6 p. 56	STARTUP_DELAY	—											STARTUP_P_DELAY_EN	STARTUP_DELAY_TIME				
		0	0	0	0	0	0	0	0	0	0	0	0	1	1	0	0	0
0x0000 00E8 p. 56	DSD_CTRL	—									DSD_PM_SEL	DSD_PM_EN	DSD_ZERODB	DSD_OSR			DSD_EN	
		0	0	0	0	0	0	0	0	0	0	0	0	0	0	0	0	0
0x0000 00EC p. 56	DSD_FILTER	—											DSD_HP_FEN	—				
		0	0	0	0	0	0	0	0	0	0	0	1	0	0	0	0	0

5.4 PIN_CONFIG

Address	Register	15	14	13	12	11	10	9	8	7	6	5	4	3	2	1	0	
0x0000 3D24 p. 57	PAD_FN	—						CONFIG5_FN	CONFIG4_FN	CONFIG3_FN	CONFIG2_FN	SPI_SCK_FN	SPI_CS_FN	ASP_DIN4_FN	ASP_DIN3_FN	ASP_DIN2_FN	—	—
		0	0	0	0	0	0	0	0	0	0	0	0	0	0	0	0	0
0x0000 3D28 p. 57	PAD_LVL	—						CONFIG5_LVL	CONFIG4_LVL	CONFIG3_LVL	CONFIG2_LVL	SPI_SCK_LVL	SPI_CS_LVL	ASP_DIN4_LVL	ASP_DIN3_LVL	ASP_DIN2_LVL	—	—
		0	0	0	0	0	0	0	0	0	0	0	0	0	0	0	0	0

6 Register Descriptions

This section describes each of the control port registers.

This register view is for the CS4308P.

- The register field default values are established upon the deassertion of the $\overline{\text{RESET}}$ pin or following soft reset.
- A "—" represents a reserved field/access type.
- The reserved field values must not be modified.
- The registers are 16 bits wide, and only word transactions are allowed.
- All visible fields are read/write except where indicated with the following shading:

Read/write access
 Read-only access
 Write-only access

6.1 DEVID

6.1.1 DEVID

Address: 0x0000 0000

RO	15	14	13	12	11	10	9	8	7	6	5	4	3	2	1	0
	DEVID															
Default	0	1	0	0	0	0	1	1	0	0	0	0	1	0	0	0

Bits	Name	Description
15:0	DEVID	This register indicates the Device ID CS4308P. 0x0000–0x4307 = Reserved 0x4308 = CS4308P 0x4309–0xFFFF = Reserved

6.1.2 REVID

Address: 0x0000 0004

RO	15...8	7	6	5	4	3	2	1	0	
	AREVID				MTLREVID					
Default	0x00	1	0	1	0	0	0	0	0	

Bits	Name	Description
15:8	—	Reserved
7:4	AREVID	This field indicates the all-layer device revision. 0x0–0x9 = Reserved 0xA = (Default) Revision Ax 0xB–0xF = Reserved
3:0	MTLREVID	This field indicates the metal-layer device revision. 0x0 = (Default) Revision x0 0x1–0xF = Reserved

6.1.3 SW_RESET

Address: 0x0000 0022

WO	15	14	13	12	11	10	9	8	7	6	5	4	3	2	1	0
	SW_RESET								—							
Default	0	0	0	0	0	0	0	0	0	0	0	0	0	0	0	0

Bits	Name	Description
15:8	SW_RESET	Software Reset. Writing 0x5A triggers a reset. 0x00 = (Default) No action 0x01–0x59 = Reserved 0x5A = Software reset 0x5B–0xFF = Reserved
7:0	—	Reserved

6.2 CONFIG

6.2.1 CLK_CFG_0

Address: 0x0000 0040

RW	15	14	13	12	11	10	9	8	7	6	5	4	3	2	1	0
	—			SYSCLK_SRC	—				PLL_REFCLK_FREQ		—			PLL_REFCLK_SRC		
Default	0	0	0	1	0	0	0	0	0	0	1	1	0	0	0	0

Bits	Name	Description
15:13	—	Reserved
12	SYSCLK_SRC	System clock source. If MCLK is selected, the PLL is bypassed. 0 = MCLK 1 = (Default) PLL
11:6	—	Reserved
5:4	PLL_REFCLK_FREQ	PLL reference clock frequency. The selection must match the frequency of the selected input reference. 00 = 3.072/2.8224 MHz 01 = 6.144/5.6448 MHz 10 = 12.288/11.2896 MHz 11 = (Default) 24.576/22.5792 MHz
3:1	—	Reserved
0	PLL_REFCLK_SRC	PLL reference clock source. Note the BCLK reference is only valid in ASP Secondary Mode. 0 = (Default) BCLK 1 = MCLK

6.2.2 CLK_CFG_1

Address: 0x0000 0042

RW	15...8	7	6	5	4	3	2	1	0
	—	SAMPLE_RATE							—
Default	0x00	0	0	0	0	0	0	0	1

Bits	Name	Description
15:3	—	Reserved
2:0	SAMPLE_RATE	Audio sample frequency. Note the sample rate must be integer-related to the system clock frequency. Auto-detect is only valid if sample rate = 32-192kHz, clock reference = MCLK, and the ASP is in Secondary Mode. 000 = 32 kHz 001 = (Default) 48/44.1 kHz 010 = 96/88.2 kHz 011 = 192/176.4 kHz 100 = 384/356.8 kHz 101 = 768/705.6 kHz 110 = Auto-detect 111 = Reserved

6.2.3 CHIP_ENABLE

Address: 0x0000 0044

RW	15...8	7	6	5	4	3	2	1	0
	—	GLOBAL_EN							
Default	0x00	0	0	0	0	0	0	0	0

Bits	Name	Description
15:1	—	Reserved
0	GLOBAL_EN	Global enable. Set to 1 to configure and enable all functions. Clear to 0 to disable. Note the clocking and ASP control registers are only valid on the rising edge of GLOBAL_EN. It is recommended to select the disabled state (GLOBAL_EN=0) before writing to these registers.

6.2.4 ASP_CFG
Address: 0x0000 0048

RW	15...8	7	6	5	4	3	2	1	0
	—	—	ASP_BCLK_INV	ASP_PRIMARY	—	—	—	ASP_BCLK_FREQ	—
Default	0x00	0	0	0	0	0	0	0	0

Bits	Name	Description
15:7	—	Reserved
6	ASP_BCLK_INV	ASP BCLK polarity. Selects the valid BCLK edge for data sampling. In non-inverted mode, DIN data is valid on BCLK rising edge. In inverted mode, DIN data is valid on BCLK falling edge. 0 = (Default) Non-inverted 1 = Inverted
5	ASP_PRIMARY	ASP Primary/Secondary Mode select. In ASP Primary Mode, BCLK and FSYNC are outputs. In ASP Secondary Mode, BCLK and FSYNC are inputs. 0 = (Default) Secondary Mode 1 = Primary Mode
4:2	—	Reserved
1:0	ASP_BCLK_FREQ	ASP BCLK frequency. The BCLK frequency must be high enough to support the required number of data bits at the selected sample rate. Only valid in ASP Primary Mode. Note the BCLK frequency is integer-related to the system clock frequency i.e., multiples of 3.072 MHz for 12.288 / 24.576 MHz system clock, or multiples of 2.8224 MHz for 11.2896 / 22.5792 MHz system clock. 00 = (Default) 3.072/2.8224 MHz 01 = 6.144/5.6448 MHz 10 = 12.288/11.2896 MHz 11 = 24.576/22.5792 MHz

6.2.5 SIGNAL_PATH_CFG
Address: 0x0000 0050

RW	15	14	13	12	11	10	9	8	7	6	5	4	3	2	1	0
	—	—	—	—	—	—	ASP_CH_REVERSE	—	—	—	—	ASP_TDM_SLOT	—	—	—	ASP_FORMAT
Default	0	0	0	0	0	0	0	0	0	0	0	0	0	0	0	0

Bits	Name	Description
15:10	—	Reserved
9	ASP_CH_REVERSE	ASP channel-ordering reversal. Selects normal- or reverse-order ASP data format. 0 = (Default) Normal 1 = Reverse
8:6	—	Reserved
5:3	ASP_TDM_SLOT	TDM slot select. Configures which TDM slots are used in TDM maximum-time-slots mode. Note the valid selections vary depending on whether the device is configured in 8-channel mode (default), or in 4-/2-channel summing modes. In 8-channel mode (default), valid selections are 0x0 or 0x4 only. In 4-channel summing mode, valid selections are 0x0, 0x2, 0x4, or 0x6. 000 = (Default) Slots 0-7 (8-ch), Slots 0-3 (4-ch), Slots 0-1 (2-ch) 001 = Slots 2-3 (2-ch) 010 = Slots 4-7 (4-ch), Slots 4-5 (2-ch) 011 = Slots 6-7 (2-ch) 100 = Slots 8-15 (8-ch), Slots 8-11 (4-ch), Slots 8-9 (2-ch) 101 = Slots 10-11 (2-ch) 110 = Slots 12-15 (4-ch), Slots 12-13 (2-ch) 111 = Slots 14-15 (2-ch)
2:0	ASP_FORMAT	ASP data format. Selects how the audio samples are arranged within the FSYNC frame. 000 = (Default) I2S Mode 001 = Left-Justified Mode 010–101 = Reserved 110 = TDM Maximum Time Slots Mode 111 = TDM Minimum Time Slots Mode

6.3 OUTPUT_PATH

6.3.1 OUT_ENABLES

Address: 0x0000 00C0

RW	15...8	7	6	5	4	3	2	1	0
	—	OUT8_DAC_EN	OUT7_DAC_EN	OUT6_DAC_EN	OUT5_DAC_EN	OUT4_DAC_EN	OUT3_DAC_EN	OUT2_DAC_EN	OUT1_DAC_EN
Default	0x00	0	0	0	0	0	0	0	0

Bits	Name	Description
15:8	—	Reserved
7	OUT8_DAC_EN	Channel 8 output enable. 0 = (Default) Disabled 1 = Enabled
6	OUT7_DAC_EN	Channel 7 output enable. 0 = (Default) Disabled 1 = Enabled
5	OUT6_DAC_EN	Channel 6 output enable. 0 = (Default) Disabled 1 = Enabled
4	OUT5_DAC_EN	Channel 5 output enable. 0 = (Default) Disabled 1 = Enabled
3	OUT4_DAC_EN	Channel 4 output enable. 0 = (Default) Disabled 1 = Enabled
2	OUT3_DAC_EN	Channel 3 output enable. 0 = (Default) Disabled 1 = Enabled
1	OUT2_DAC_EN	Channel 2 output enable. 0 = (Default) Disabled 1 = Enabled
0	OUT1_DAC_EN	Channel 1 output enable. 0 = (Default) Disabled 1 = Enabled

6.3.2 OUT_RAMP_SUM

Address: 0x0000 00C2

RW	15	14	13	12	11	10	9	8	7	6	5	4	3	2	1	0
	OUT_SUM_MODE			—				OUT_RAMP_RATE_DEC			—	OUT_RAMP_RATE_INC				
Default	0	0	0	0	0	0	0	0	0	0	1	0	0	0	1	0

Bits	Name	Description
15:13	OUT_SUM_MODE	DAC output summing select. Combines the output paths in groups of two, four, or eight channels. The grouped channels must be linked together at the respective output pins. The grouped paths are configured using the control registers associated with the respective summed channel number (1 to n). 000 = (Default) No summing of channels 001 = Outputs combined in groups of two. DAC1+DAC2, DAC3+DAC4, DAC5+DAC6, DAC7+DAC8 010 = Outputs combined in groups of four. DAC1+DAC2+DAC3+DAC4, DAC5+DAC6+DAC7+DAC8 011 = Outputs combined in group of eight. DAC1+DAC2+DAC3+DAC4+DAC5+DAC6+DAC7+DAC8 100 = Outputs combined in 6-channel mode. DAC1+DAC2, DAC3+DAC4, DAC5, DAC6, DAC7, DAC8 101–111 = Reserved
12:7	—	Reserved
6:4	OUT_RAMP_RATE_DEC	DAC output volume decrease Ramp Rate (ms/6 dB), used for gain changes. This field should not be changed while a volume ramp is in progress. 000 = 0 ms 001 = 0.5 ms 010 = (Default) 1 ms 011 = 2 ms 100 = 4 ms 101 = 8 ms 110 = 15 ms 111 = 30 ms

Bits	Name	Description
3	—	Reserved
2:0	OUT_RAMP_RATE_INC	DAC output volume increase Ramp Rate (ms/6 dB), used for gain changes. This field should not be changed while a volume ramp is in progress. 000 = 0 ms 001 = 0.5 ms 010 = (Default) 1 ms 011 = 2 ms 100 = 4 ms 101 = 8 ms 110 = 15 ms 111 = 30 ms

6.3.3 OUT_DEEMPH

Address: 0x0000 00C4

RW	15...8	7	6	5	4	3	2	1	0
	—				—			OUT_DEEMPH_FILT_SEL	OUT_DEEMPH_EN
Default	0x00	0	0	0	0	0	0	0	0

Bits	Name	Description
15:2	—	Reserved
1	OUT_DEEMPH_FILT_SEL	Deemphasis filter sample-rate selection. 0 = (Default) 44.1 kHz 1 = 48.0 kHz
0	OUT_DEEMPH_EN	Deemphasis filter enable. 0 = (Default) Deemphasis disabled 1 = Deemphasis enabled

6.3.4 OUT_FILTER

Address: 0x0000 00C6

RW	15	14	13	12	11	10	9	8	7	6	5	4	3	2	1	0
				OUT_HPF_EN	—	OUT_FILTER_SEL							—			
Default	0	0	0	0	0	0	0	0	0	0	0	0	0	0	0	0

Bits	Name	Description
15:13	—	Reserved
12	OUT_HPF_EN	High-pass filter enable. 0 = (Default) HPF disabled 1 = HPF enabled
11	—	Reserved
10:8	OUT_FILTER_SEL	Digital filter select. Configures the interpolation filter. 000 = (Default) Minimum phase, Slow roll-off (44.1k-192k) 001 = Minimum phase, Fast roll-off (32k-48k)/Balanced roll-off (88.2k-768k) 010 = Linear phase, Slow roll-off (44.1k-192k) 011 = Linear phase, Fast roll-off (32k-48k)/Balanced roll-off (88.2k-768k) 100 = Reserved 101 = Minimum phase, Fast roll-off (88.2k-768k) 110 = Reserved 111 = Linear phase, Fast roll-off (88.2k-768k)
7:0	—	Reserved

6.3.5 OUT_INV

Address: 0x0000 00CA

RW	15...8	7	6	5	4	3	2	1	0
	—	OUT8_INV	OUT7_INV	OUT6_INV	OUT5_INV	OUT4_INV	OUT3_INV	OUT2_INV	OUT1_INV
Default	0x00	0	0	0	0	0	0	0	0

Bits	Name	Description
15:8	—	Reserved
7	OUT8_INV	Channel 8 DAC invert 0 = (Default) No inversion 1 = DAC data invert
6	OUT7_INV	Channel 7 DAC invert 0 = (Default) No inversion 1 = DAC data invert

Bits	Name	Description
5	OUT6_INV	Channel 6 DAC invert 0 = (Default) No inversion 1 = DAC data invert
4	OUT5_INV	Channel 5 DAC invert 0 = (Default) No inversion 1 = DAC data invert
3	OUT4_INV	Channel 4 DAC invert 0 = (Default) No inversion 1 = DAC data invert
2	OUT3_INV	Channel 3 DAC invert 0 = (Default) No inversion 1 = DAC data invert
1	OUT2_INV	Channel 2 DAC invert 0 = (Default) No inversion 1 = DAC data invert
0	OUT1_INV	Channel 1 DAC invert 0 = (Default) No inversion 1 = DAC data invert

6.3.6 OUT_VOL_CTRL1_0
Address: 0x0000 00D0

RW	15	14	13	12	11	10	9	8	7	6	5	4	3	2	1	0
	OUT1_MUTE	—							OUT1_VOL							
Default	1	0	0	0	0	0	0	0	0	0	0	0	0	0	0	0

Bits	Name	Description
15	OUT1_MUTE	DAC output channel 1 mute 0 = Unmute 1 = (Default) Mute
14:8	—	Reserved
7:0	OUT1_VOL	DAC output channel 1 Volume, -127.5dB to 0dB in 0.5dB steps 0x00 = (Default) 0.0 dB 0x01 = -0.5 dB ... 0xFF = -127.5 dB

6.3.7 OUT_VOL_CTRL1_1
Address: 0x0000 00D2

RW	15	14	13	12	11	10	9	8	7	6	5	4	3	2	1	0
	OUT2_MUTE	—							OUT2_VOL							
Default	1	0	0	0	0	0	0	0	0	0	0	0	0	0	0	0

Bits	Name	Description
15	OUT2_MUTE	DAC output channel 2 mute 0 = Unmute 1 = (Default) Mute
14:8	—	Reserved
7:0	OUT2_VOL	DAC output channel 2 Volume, -127.5dB to 0dB in 0.5dB steps 0x00 = (Default) 0.0 dB 0x01 = -0.5 dB ... 0xFF = -127.5 dB

6.3.8 OUT_VOL_CTRL2_0
Address: 0x0000 00D4

RW	15	14	13	12	11	10	9	8	7	6	5	4	3	2	1	0
	OUT3_MUTE	—							OUT3_VOL							
Default	1	0	0	0	0	0	0	0	0	0	0	0	0	0	0	0

Bits	Name	Description
15	OUT3_MUTE	DAC output channel 3 mute 0 = Unmute 1 = (Default) Mute
14:8	—	Reserved
7:0	OUT3_VOL	DAC output channel 3 Volume, -127.5dB to 0dB in 0.5dB steps 0x00 = (Default) 0.0 dB 0x01 = -0.5 dB ... 0xFF = -127.5 dB

6.3.9 OUT_VOL_CTRL2_1
Address: 0x0000 00D6

RW	15	14	13	12	11	10	9	8	7	6	5	4	3	2	1	0
	OUT4_MUTE	—							OUT4_VOL							
Default	1	0	0	0	0	0	0	0	0	0	0	0	0	0	0	0

Bits	Name	Description
15	OUT4_MUTE	DAC output channel 4 mute 0 = Unmute 1 = (Default) Mute
14:8	—	Reserved
7:0	OUT4_VOL	DAC output channel 4 Volume, -127.5dB to 0dB in 0.5dB steps 0x00 = (Default) 0.0 dB 0x01 = -0.5 dB ... 0xFF = -127.5 dB

6.3.10 OUT_VOL_CTRL3_0
Address: 0x0000 00D8

RW	15	14	13	12	11	10	9	8	7	6	5	4	3	2	1	0
	OUT5_MUTE	—							OUT5_VOL							
Default	1	0	0	0	0	0	0	0	0	0	0	0	0	0	0	0

Bits	Name	Description
15	OUT5_MUTE	DAC output channel 5 mute 0 = Unmute 1 = (Default) Mute
14:8	—	Reserved
7:0	OUT5_VOL	DAC output channel 5 Volume, -127.5dB to 0dB in 0.5dB steps 0x00 = (Default) 0.0 dB 0x01 = -0.5 dB ... 0xFF = -127.5 dB

6.3.11 OUT_VOL_CTRL3_1
Address: 0x0000 00DA

RW	15	14	13	12	11	10	9	8	7	6	5	4	3	2	1	0
	OUT6_MUTE	—							OUT6_VOL							
Default	1	0	0	0	0	0	0	0	0	0	0	0	0	0	0	0

Bits	Name	Description
15	OUT6_MUTE	DAC output channel 6 mute 0 = Unmute 1 = (Default) Mute
14:8	—	Reserved
7:0	OUT6_VOL	DAC output channel 6 Volume, -127.5dB to 0dB in 0.5dB steps 0x00 = (Default) 0.0 dB 0x01 = -0.5 dB ... 0xFF = -127.5 dB

6.3.12 OUT_VOL_CTRL4_0
Address: 0x0000 00DC

RW	15	14	13	12	11	10	9	8	7	6	5	4	3	2	1	0
	OUT7_MUTE	—							OUT7_VOL							
Default	1	0	0	0	0	0	0	0	0	0	0	0	0	0	0	0

Bits	Name	Description
15	OUT7_MUTE	DAC output channel 7 mute 0 = Unmute 1 = (Default) Mute
14:8	—	Reserved
7:0	OUT7_VOL	DAC output channel 7 Volume, -127.5dB to 0dB in 0.5dB steps 0x00 = (Default) 0.0 dB 0x01 = -0.5 dB ... 0xFF = -127.5 dB

6.3.13 OUT_VOL_CTRL4_1
Address: 0x0000 00DE

RW	15	14	13	12	11	10	9	8	7	6	5	4	3	2	1	0
	OUT8_MUTE	—							OUT8_VOL							
Default	1	0	0	0	0	0	0	0	0	0	0	0	0	0	0	0

Bits	Name	Description
15	OUT8_MUTE	DAC output channel 8 mute 0 = Unmute 1 = (Default) Mute
14:8	—	Reserved
7:0	OUT8_VOL	DAC output channel 8 Volume, -127.5dB to 0dB in 0.5dB steps 0x00 = (Default) 0.0 dB 0x01 = -0.5 dB ... 0xFF = -127.5 dB

6.3.14 OUT_VOL_CTRL5
Address: 0x0000 00E0

WO	15...8	7	6	5	4	3	2	1	0
	—	—							OUT_VU
Default	0x00	0	0	0	0	0	0	0	0

Bits	Name	Description
15:1	—	Reserved
0	OUT_VU	Global output volume update trigger 0 = (Default) No action 1 = Write 1 to trigger an update of all output volume/mute registers

6.3.15 SHUTDOWN_CTRL
Address: 0x0000 00E4

RW	15...8	7	6	5	4	3	2	1	0
	—	—							DAC_REF_DISABLE
Default	0x00	0	0	0	0	0	0	0	0

Bits	Name	Description
15:1	—	Reserved
0	DAC_REF_DISABLE	DAC reference shutdown control. Can be used to minimize power consumption if all output paths are disabled. 0 = (Default) Enable DAC reference 1 = Shutdown DAC reference

6.3.16 STARTUP_DELAY
Address: 0x0000 00E6

RW	15...8	7	6	5	4	3	2	1	0
	—					STARTUP_DELAY_EN		STARTUP_DELAY_TIME	
Default	0x00	0	0	0	0	1	1	0	0

Bits	Name	Description
15:4	—	Reserved
3	STARTUP_DELAY_EN	Startup delay enable. Can be used to avoid raised noise floor during DAC reference start-up. 0 = Disabled 1 = (Default) Enabled
2:0	STARTUP_DELAY_TIME	Startup delay time. Can be used to avoid raised noise floor during DAC reference start-up. 000 = 100 ms 001 = 250 ms 010 = 500 ms 011 = 750 ms 100 = (Default) 1 s 101 = 1.25 s 110 = 1.5 s 111 = 2 s

6.3.17 DSD_CTRL
Address: 0x0000 00E8

RW	15...8	7	6	5	4	3	2	1	0
	—	—	DSD_PM_SEL	DSD_PM_EN	DSD_ZERODB		DSD_OSR		DSD_EN
Default	0x00	0	0	0	0	0	0	0	0

Bits	Name	Description
15:7	—	Reserved
6	DSD_PM_SEL	DSD phase modulation mode clock rate select. 0 = (Default) DSD clock at 2 x OSR rate 1 = DSD clock at OSR rate
5	DSD_PM_EN	DSD phase modulation enable. 0 = (Default) Disabled 1 = Enabled
4	DSD_ZERODB	DSD input 0 dB level. 0 = (Default) SACD +3.1 dB level matches PCM 0 dBFS level 1 = SACD 0 dB level matches PCM 0 dBFS level
3:1	DSD_OSR	DSD oversample rate (OSR). 000 = (Default) 64 Fs 001 = 128 Fs 010 = 256 Fs 011 = Reserved 100 = 512 Fs 101–111 = Reserved
0	DSD_EN	DSD interface enable. Selects ASP or DSD signal path. 0 = (Default) Select ASP path 1 = Select DSD path

6.3.18 DSD_FILTER
Address: 0x0000 00EC

RW	15...8	7	6	5	4	3	2	1	0
	—				DSD_HPF_EN				
Default	0x00	0	0	0	1	0	0	0	0

Bits	Name	Description
15:5	—	Reserved
4	DSD_HPF_EN	DSD high-pass filter enable. 0 = Disabled 1 = (Default) Enabled
3:0	—	Reserved

6.4 PIN_CONFIG

6.4.1 PAD_FN

Address: 0x0000 3D24

RW	15	14	13	12	11	10	9	8	7	6	5	4	3	2	1	0
	—						CONFIG5_FN	CONFIG4_FN	CONFIG3_FN	CONFIG2_FN	SPI_SCK_FN	SPI_CS_FN	ASP_DIN4_FN	ASP_DIN3_FN	ASP_DIN2_FN	—
Default	0	0	0	0	0	0	0	0	0	0	0	0	0	0	0	0

Bits	Name	Description
15:10	—	Reserved
9	CONFIG5_FN	CONFIG5 pin function select 0 = (Default) HW config 1 = GP output
8	CONFIG4_FN	CONFIG4 pin function select 0 = (Default) HW config 1 = GP output
7	CONFIG3_FN	CONFIG3 pin function select 0 = (Default) HW config 1 = GP output
6	CONFIG2_FN	CONFIG2 pin function select 0 = (Default) HW config 1 = GP output
5	SPI_SCK_FN	SPI_SCK pin function select 0 = (Default) SPI_SCK 1 = GP output
4	SPI_CS_FN	SPI_CS pin function select 0 = (Default) SPI_CS 1 = GP output
3	ASP_DIN4_FN	ASP_DIN4 pin function select 0 = (Default) ASP_DIN4 1 = GP output
2	ASP_DIN3_FN	ASP_DIN3 pin function select 0 = (Default) ASP_DIN3 1 = GP output
1	ASP_DIN2_FN	ASP_DIN2 pin function select 0 = (Default) ASP_DIN2 1 = GP output
0	—	Reserved

6.4.2 PAD_LVL

Address: 0x0000 3D28

RW	15	14	13	12	11	10	9	8	7	6	5	4	3	2	1	0
	—						CONFIG5_LVL	CONFIG4_LVL	CONFIG3_LVL	CONFIG2_LVL	SPI_SCK_LVL	SPI_CS_LVL	ASP_DIN4_LVL	ASP_DIN3_LVL	ASP_DIN2_LVL	—
Default	0	0	0	0	0	0	0	0	0	0	0	0	0	0	0	0

Bits	Name	Description
15:10	—	Reserved
9	CONFIG5_LVL	CONFIG5 output level. Sets the output level if CONFIG5 is configured as GP output. 0 = (Default) Logic 0 1 = Logic 1
8	CONFIG4_LVL	CONFIG4 output level. Sets the output level if CONFIG4 is configured as GP output. 0 = (Default) Logic 0 1 = Logic 1
7	CONFIG3_LVL	CONFIG3 output level. Sets the output level if CONFIG3 is configured as GP output. 0 = (Default) Logic 0 1 = Logic 1
6	CONFIG2_LVL	CONFIG2 output level. Sets the output level if CONFIG2 is configured as GP output. 0 = (Default) Logic 0 1 = Logic 1

Bits	Name	Description
5	SPI_SCK_LVL	SPI_SCK output level. Sets the output level if SPI_SCK is configured as GP output. 0 = (Default) Logic 0 1 = Logic 1
4	SPI_CS_LVL	SPI_CS output level. Sets the output level if SPI_CS is configured as GP output. 0 = (Default) Logic 0 1 = Logic 1
3	ASP_DIN4_LVL	ASP_DIN4 output level. Sets the output level if ASP_DIN4 is configured as GP output. 0 = (Default) Logic 0 1 = Logic 1
2	ASP_DIN3_LVL	ASP_DIN3 output level. Sets the output level if ASP_DIN3 is configured as GP output. 0 = (Default) Logic 0 1 = Logic 1
1	ASP_DIN2_LVL	ASP_DIN2 output level. Sets the output level if ASP_DIN2 is configured as GP output. 0 = (Default) Logic 0 1 = Logic 1
0	—	Reserved

7 Performance Plots

7.1 DAC Filter Response

The DAC filter performance is described in this section. Note that the group-delay plots represent the filter only—see [Table 3-5](#) for full-path latency.

DAC Filter Response—Fast Roll-Off, 32 kHz Sample Rate

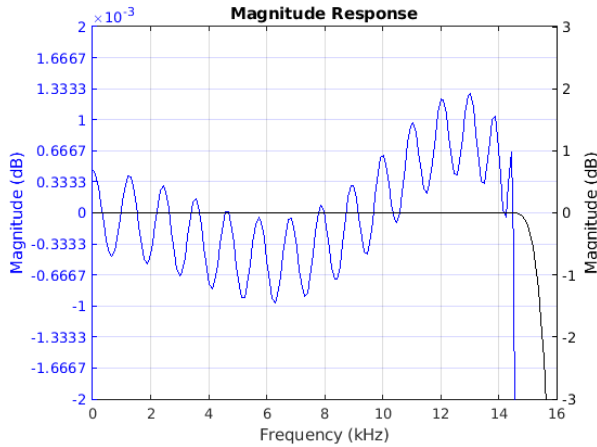

Figure 7-1. Passband Magnitude

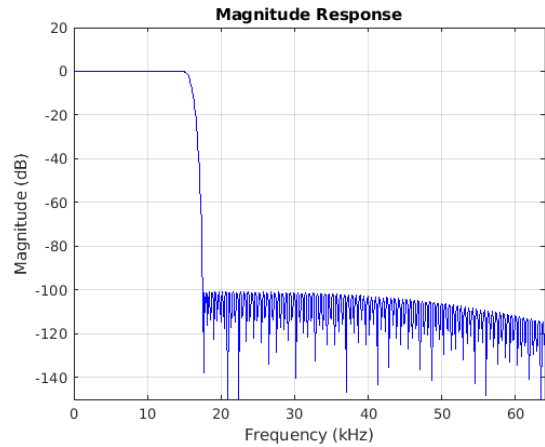

Figure 7-2. Stopband Magnitude

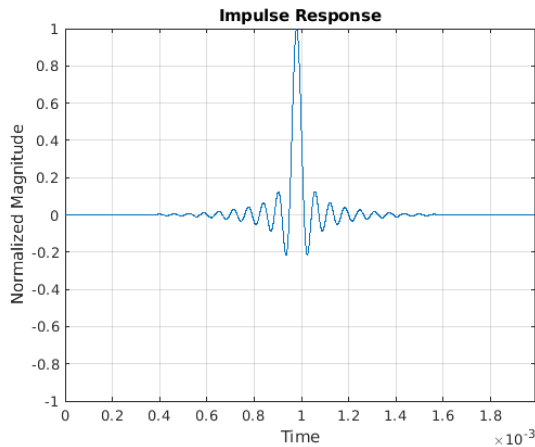

Figure 7-3. Impulse Response—Linear Phase

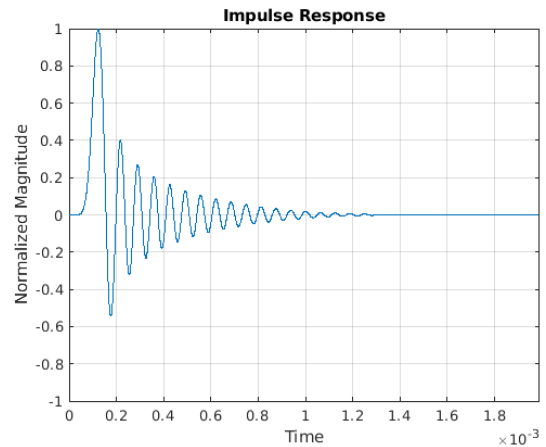

Figure 7-4. Impulse Response—Minimum Phase

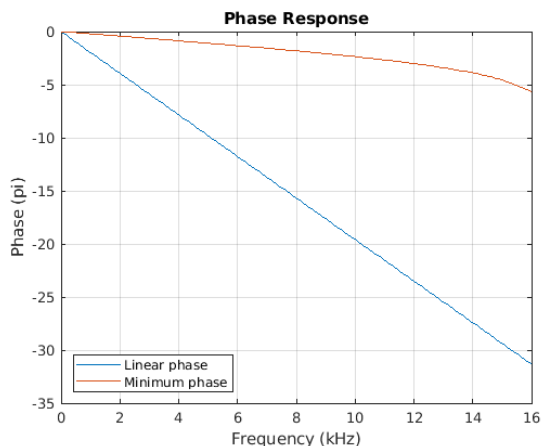

Figure 7-5. Phase vs. Frequency

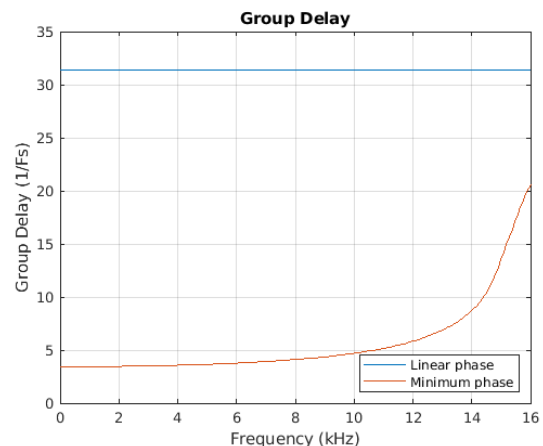
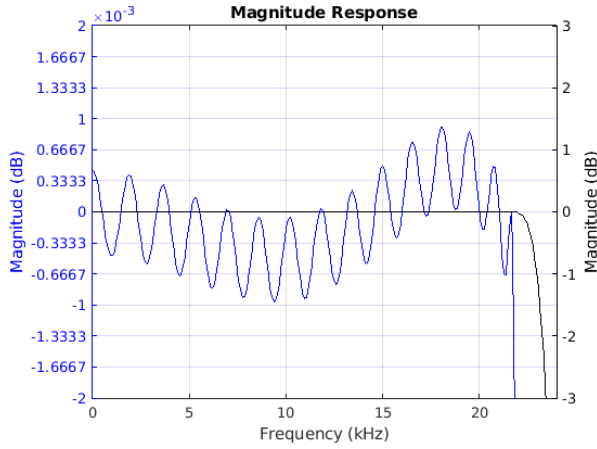
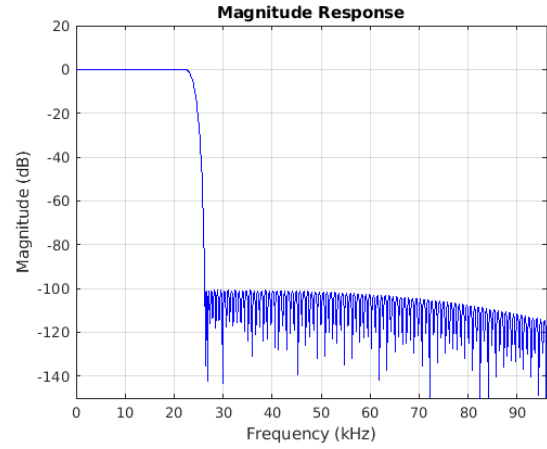
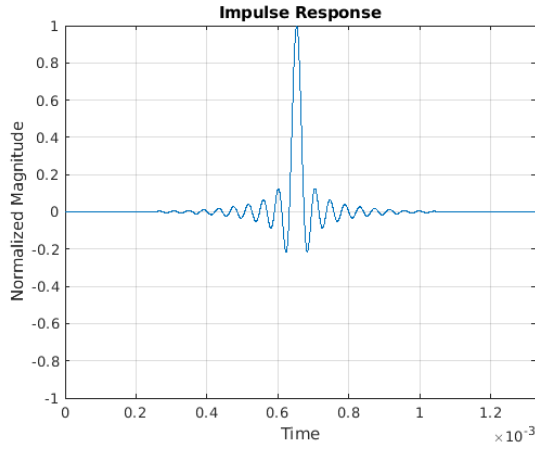
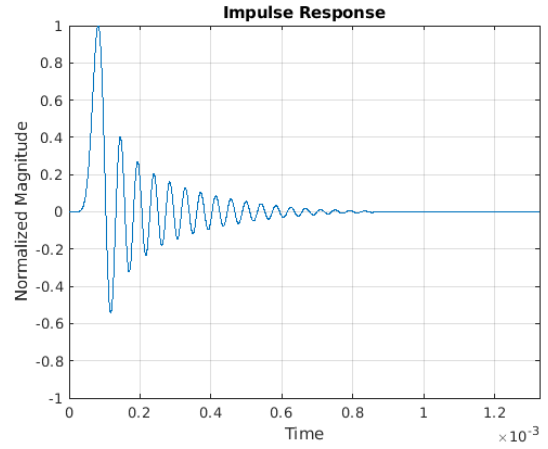
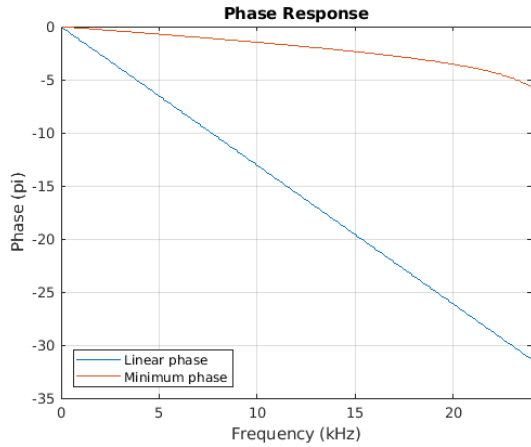
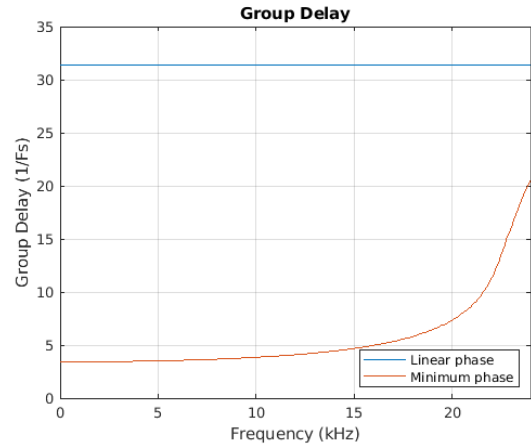
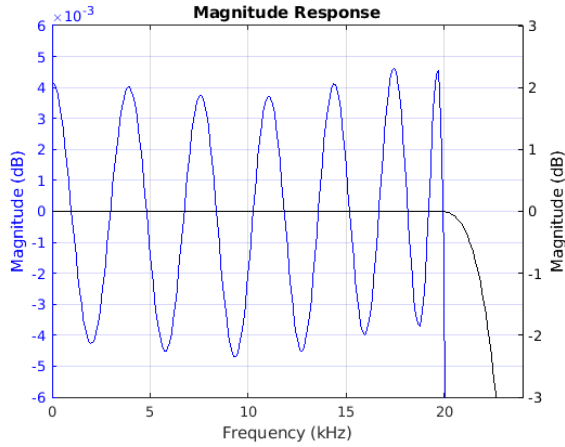
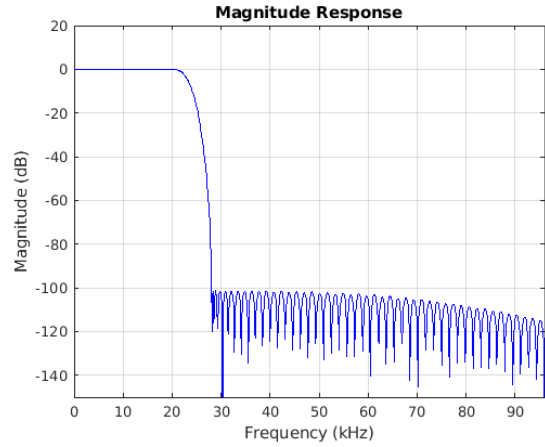
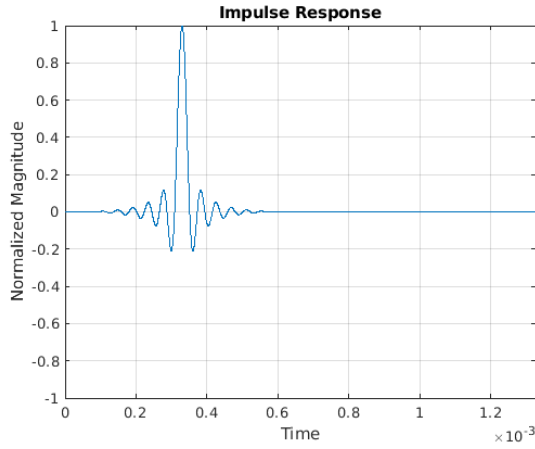
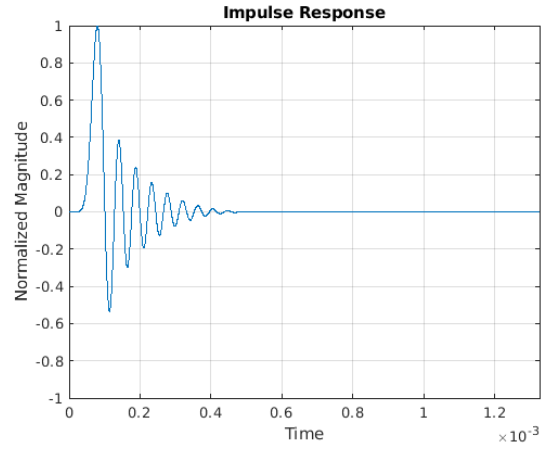
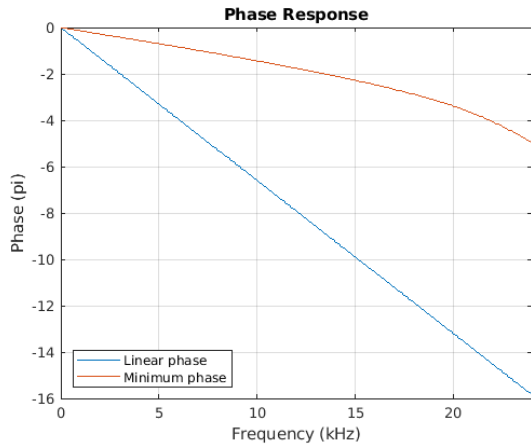
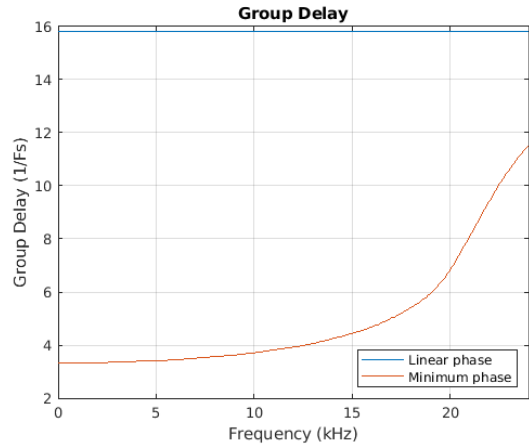
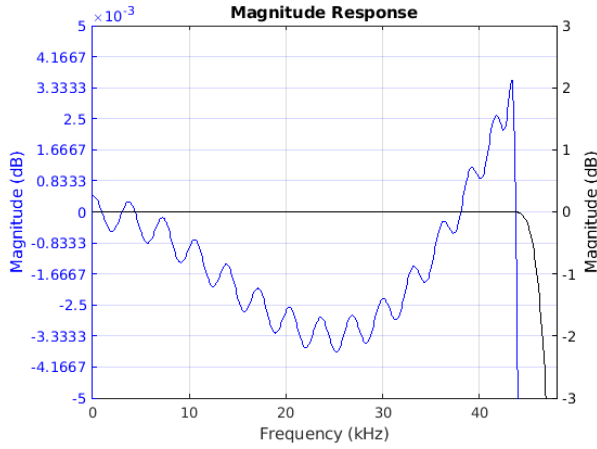
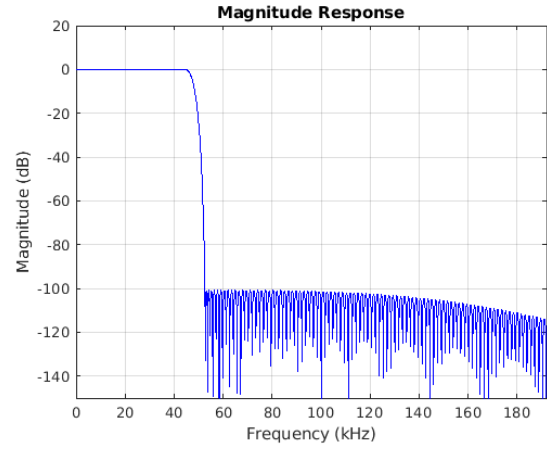
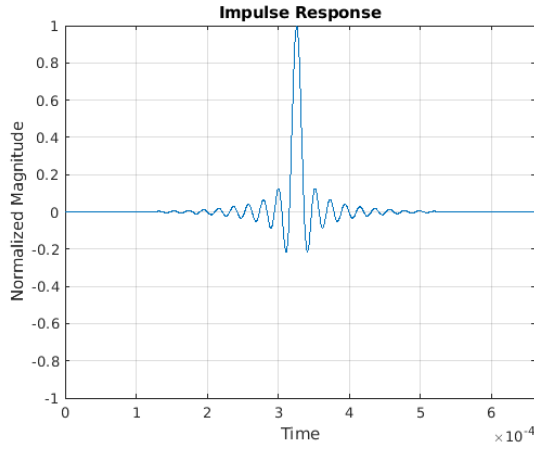
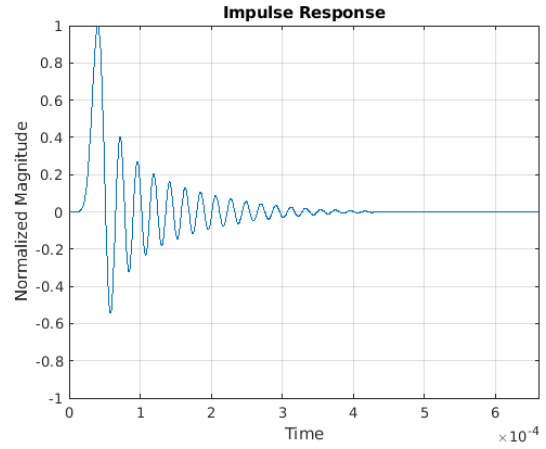
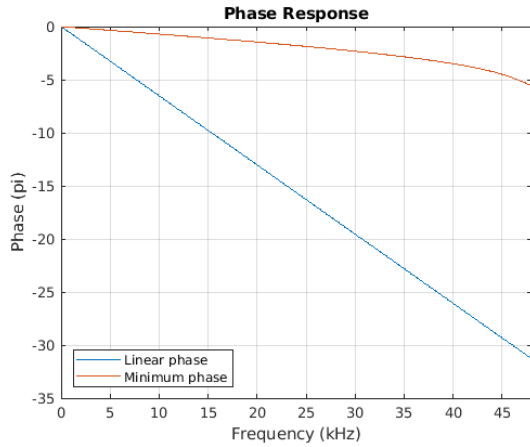
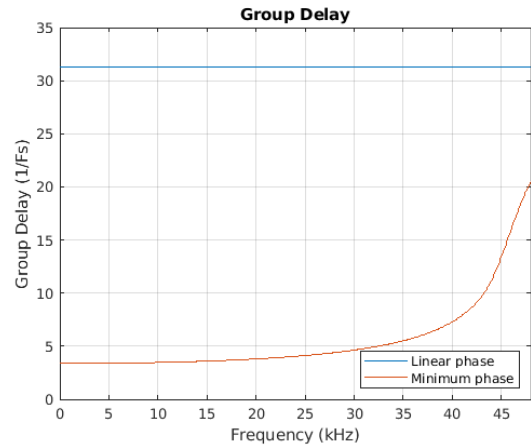
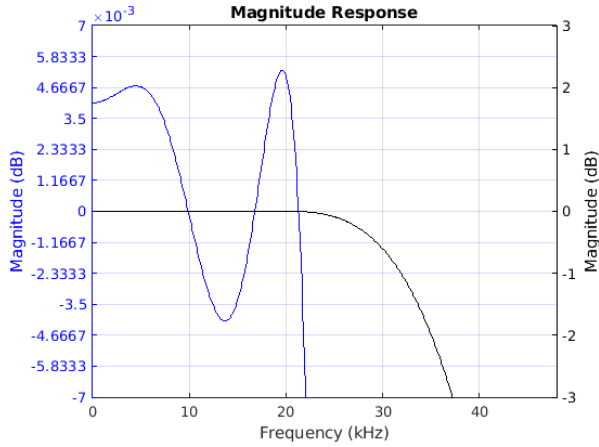
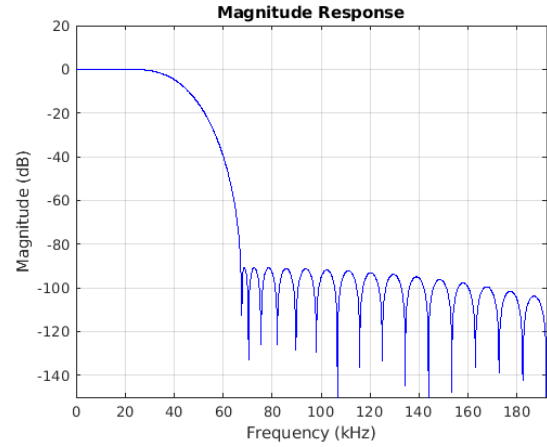
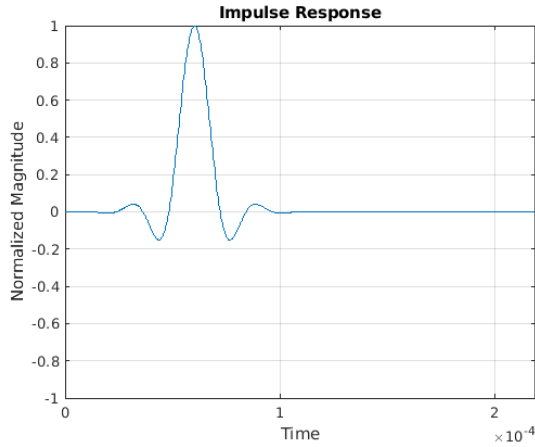
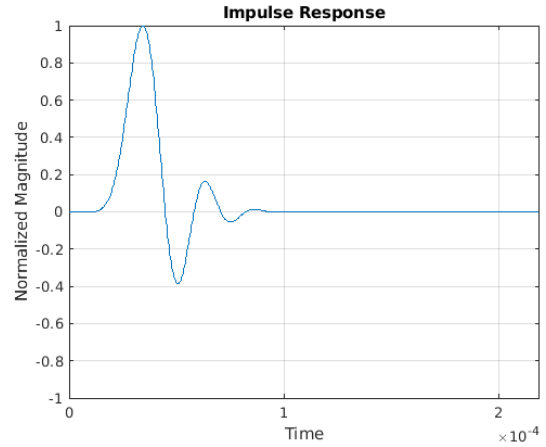
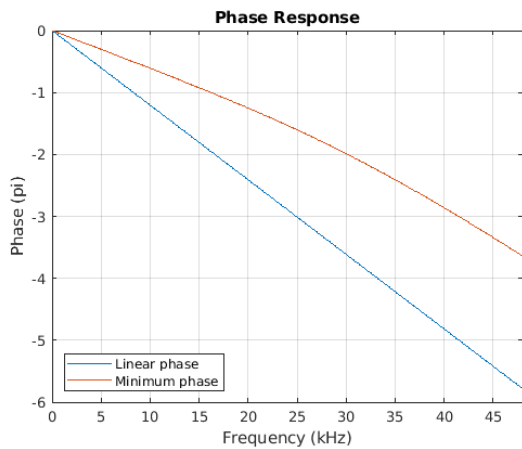
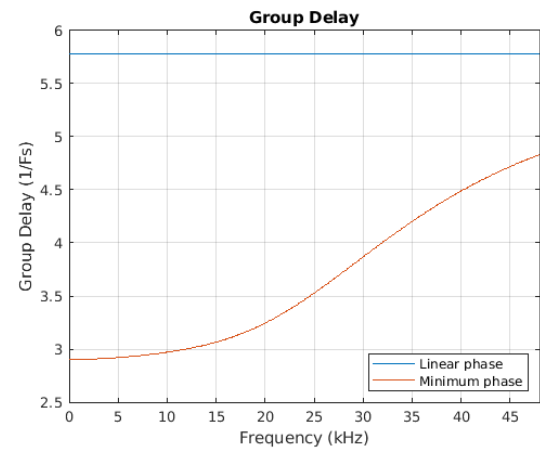

Figure 7-6. Group Delay vs. Frequency

DAC Filter Response—Fast Roll-Off, 48 kHz Sample Rate

Figure 7-7. Passband Magnitude

Figure 7-8. Stopband Magnitude

Figure 7-9. Impulse Response—Linear Phase

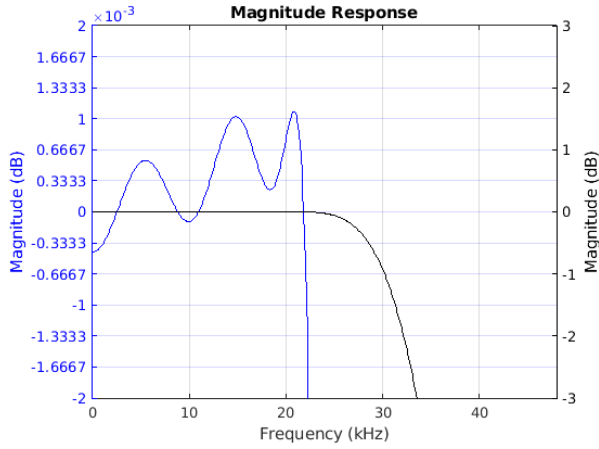
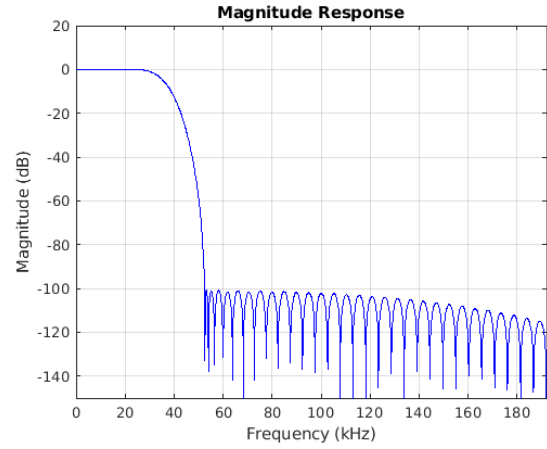
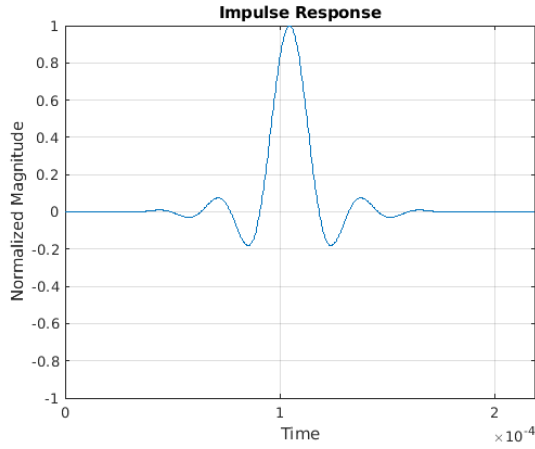
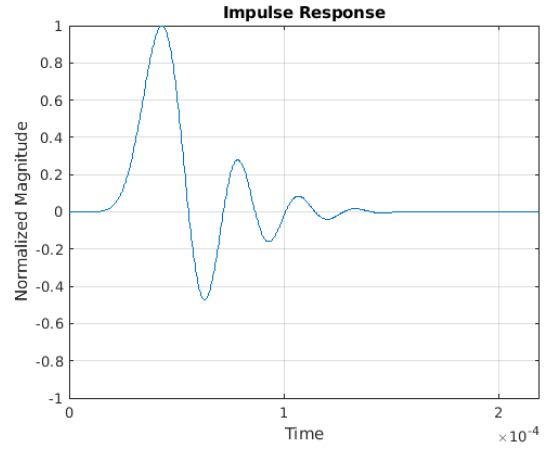
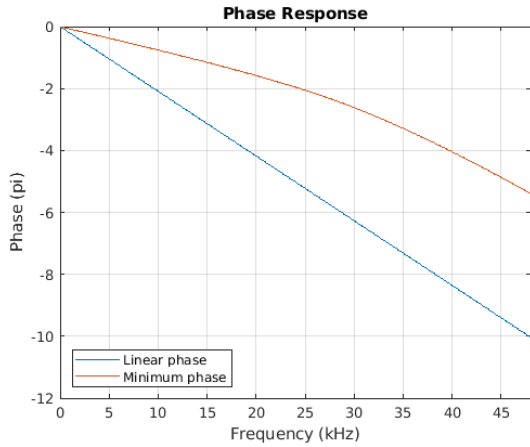
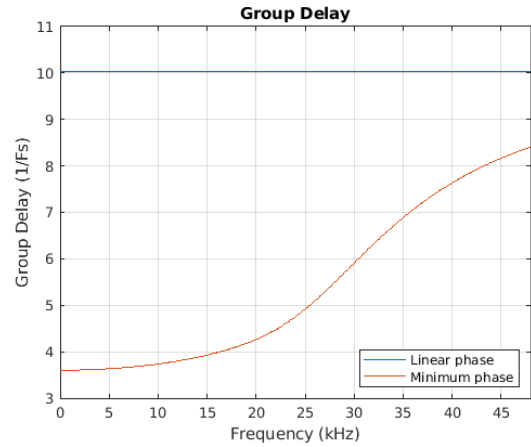
Figure 7-10. Impulse Response—Minimum Phase

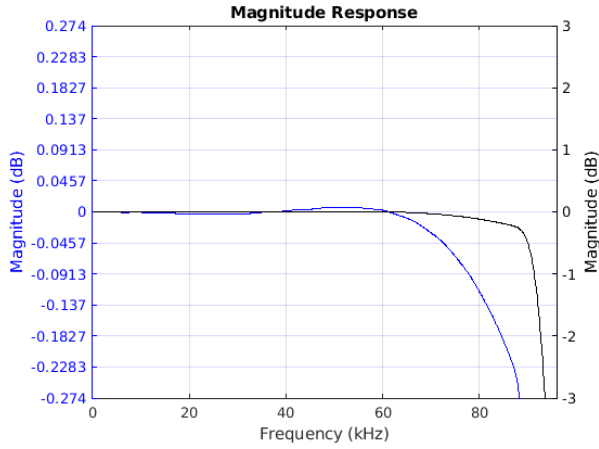
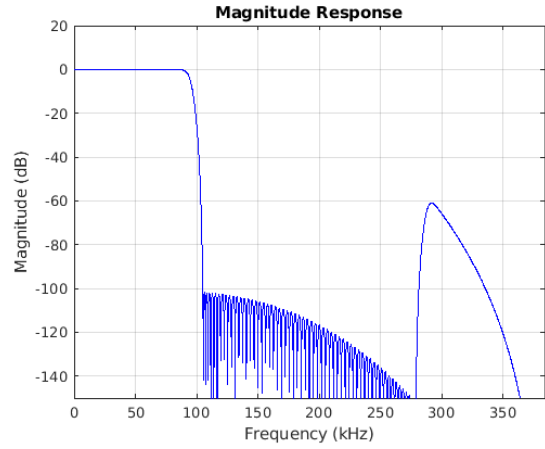
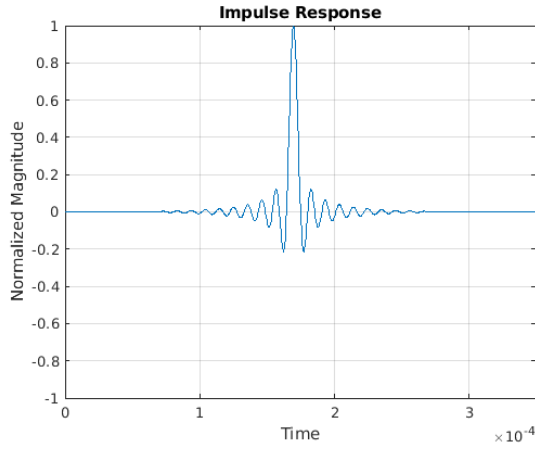
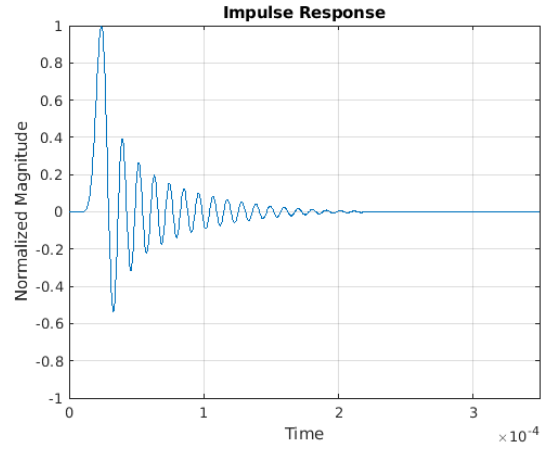
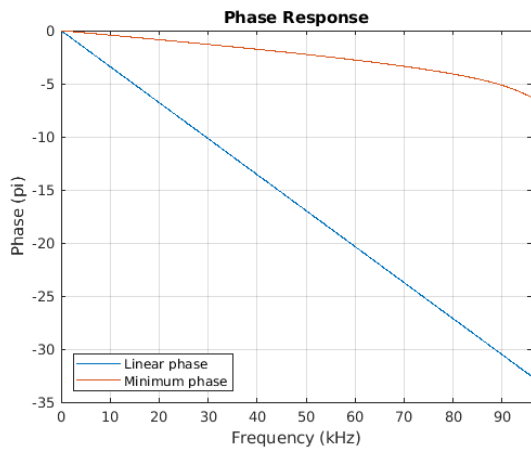
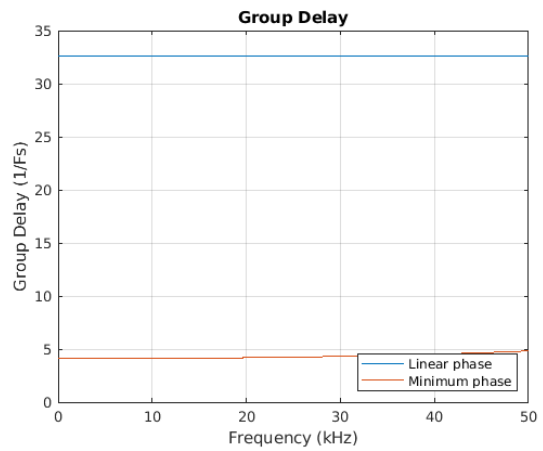
Figure 7-11. Phase vs. Frequency

Figure 7-12. Group Delay vs. Frequency

DAC Filter Response—Slow Roll-Off, 48 kHz Sample Rate

Figure 7-13. Passband Magnitude

Figure 7-14. Stopband Magnitude

Figure 7-15. Impulse Response—Linear Phase

Figure 7-16. Impulse Response—Minimum Phase

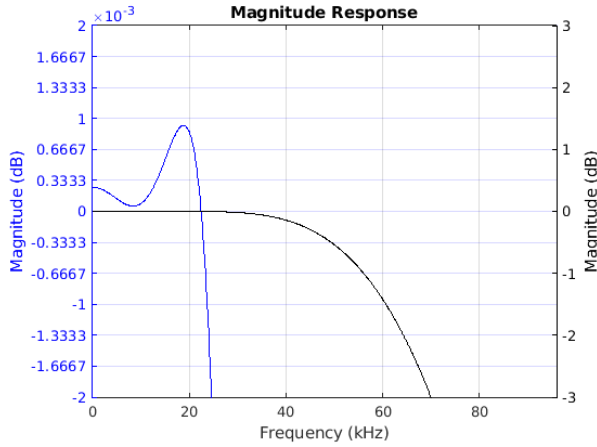
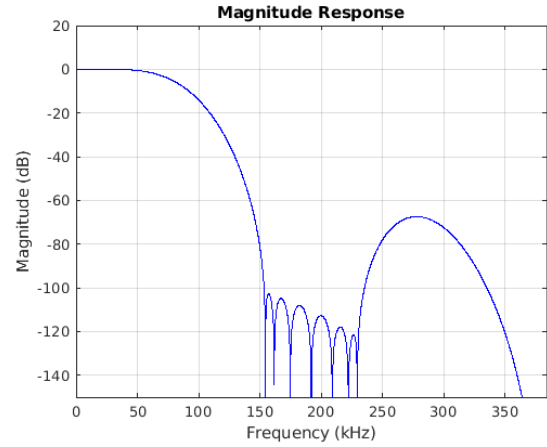
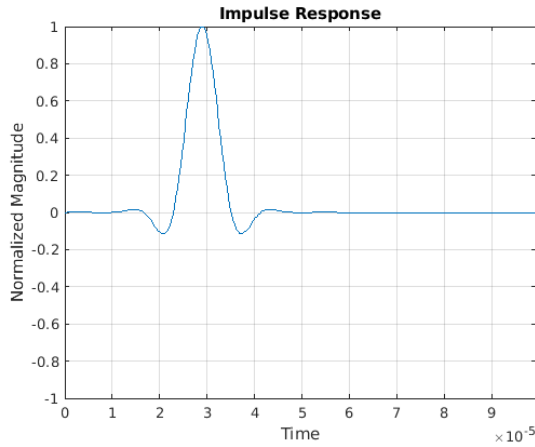
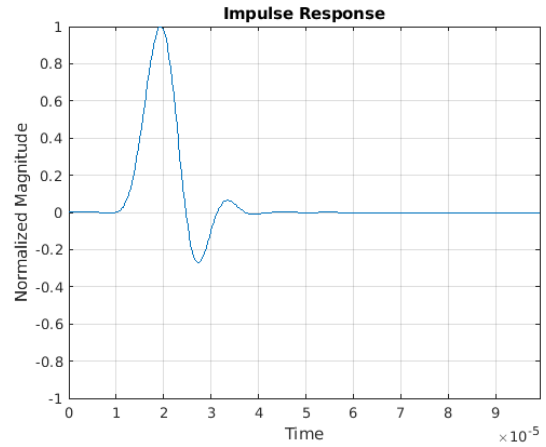
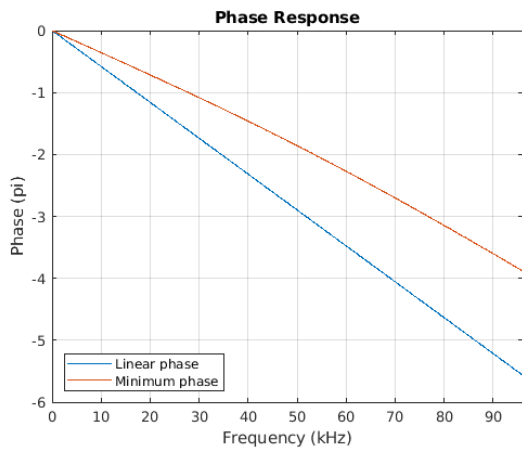
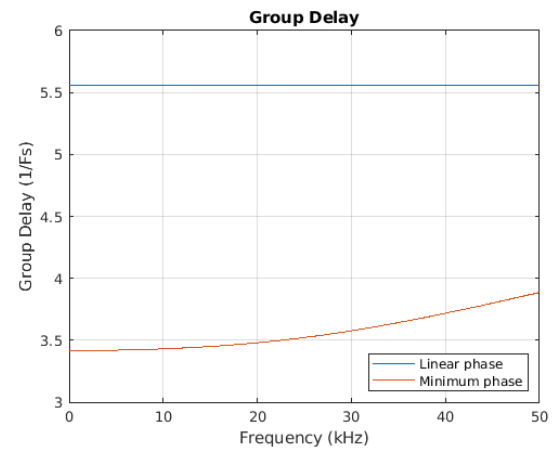
Figure 7-17. Phase vs. Frequency

Figure 7-18. Group Delay vs. Frequency

DAC Filter Response—Fast Roll-Off, 96 kHz Sample Rate

Figure 7-19. Passband Magnitude

Figure 7-20. Stopband Magnitude

Figure 7-21. Impulse Response—Linear Phase

Figure 7-22. Impulse Response—Minimum Phase

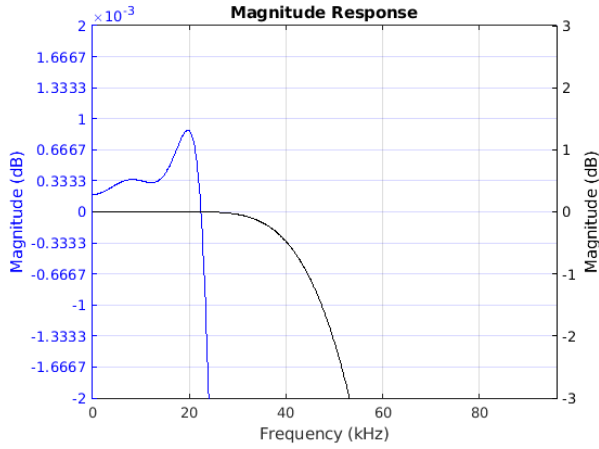
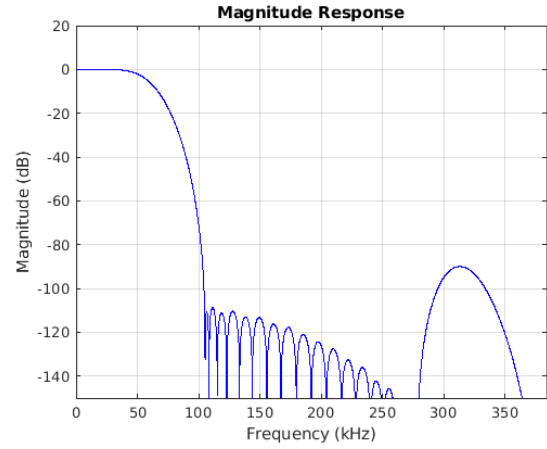
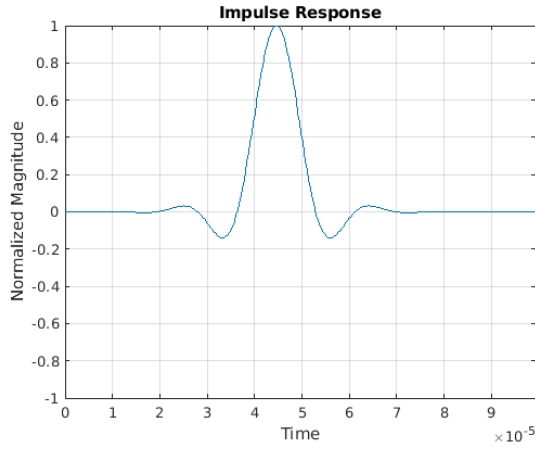
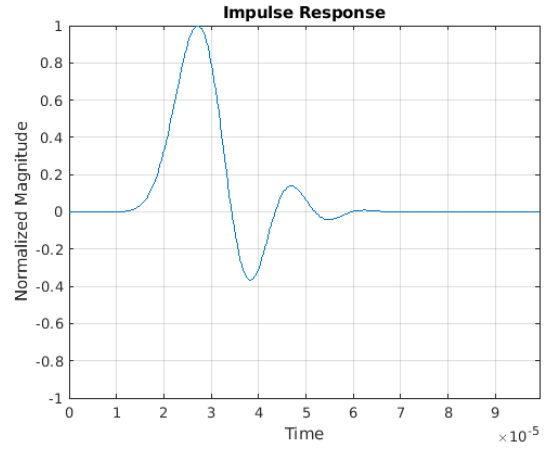
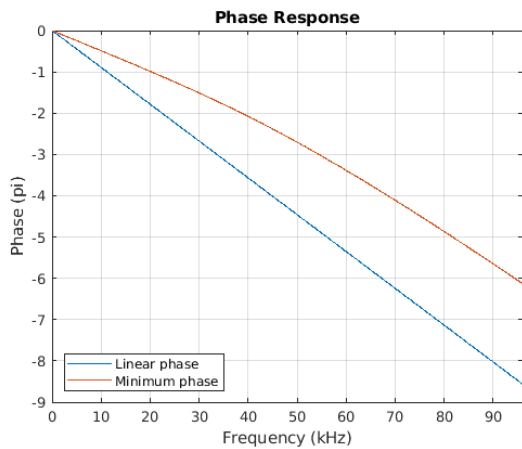
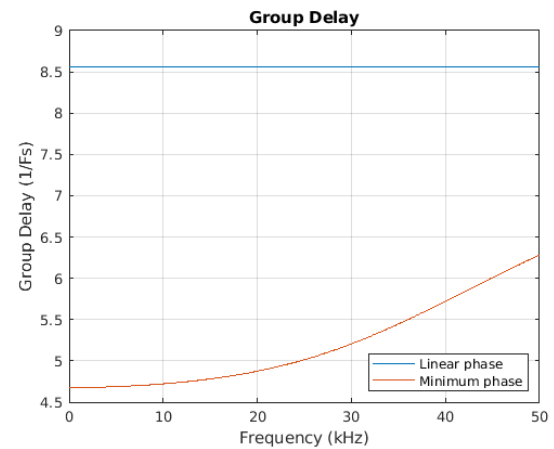
Figure 7-23. Phase vs. Frequency

Figure 7-24. Group Delay vs. Frequency

DAC Filter Response—Slow Roll-Off, 96 kHz Sample Rate

Figure 7-25. Passband Magnitude

Figure 7-26. Stopband Magnitude

Figure 7-27. Impulse Response—Linear Phase

Figure 7-28. Impulse Response—Minimum Phase

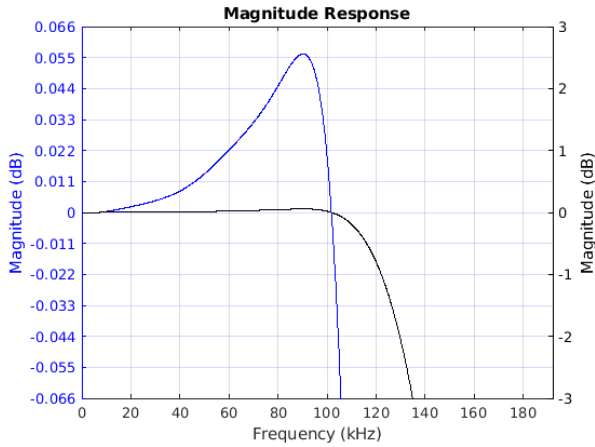
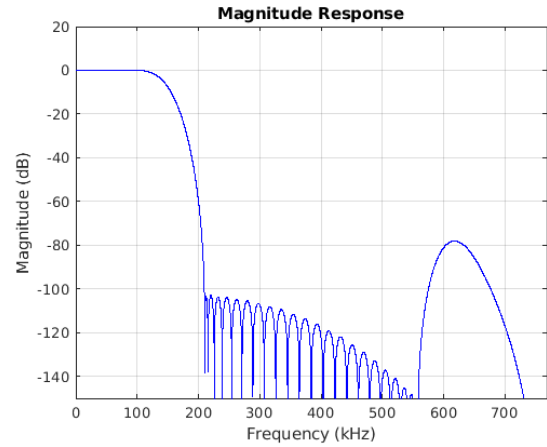
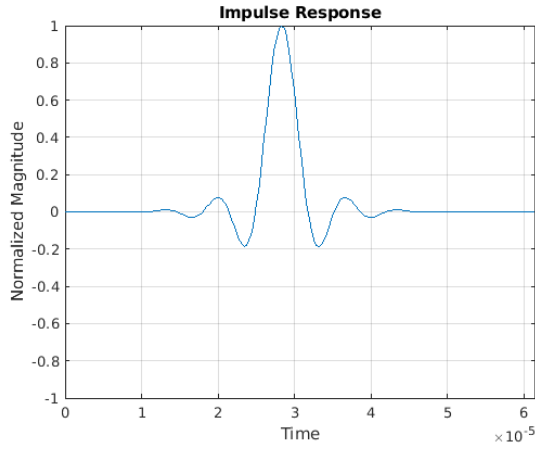
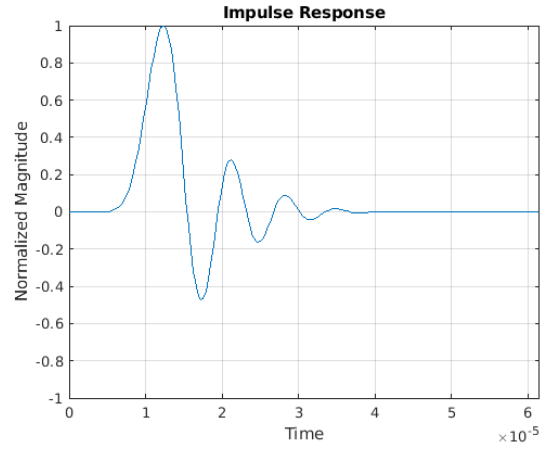
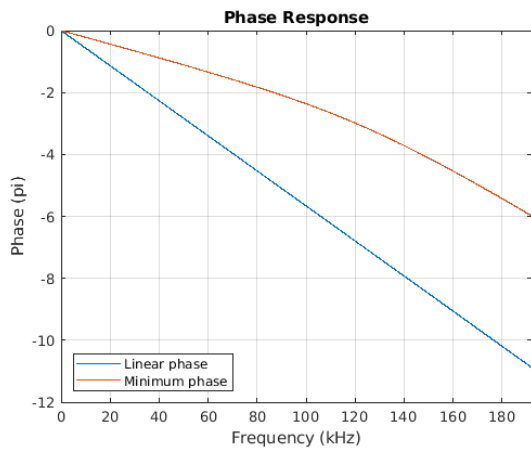
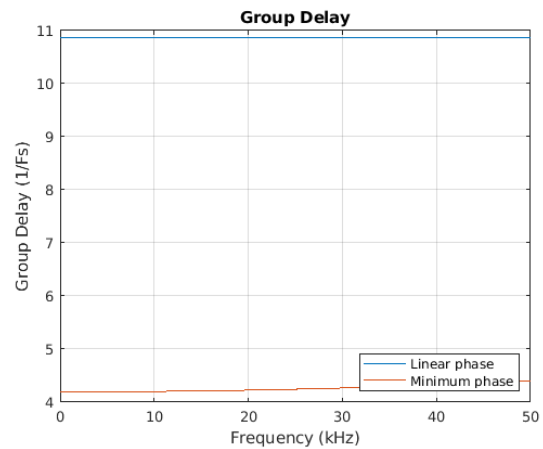
Figure 7-29. Phase vs. Frequency

Figure 7-30. Group Delay vs. Frequency

DAC Filter Response—Balanced Roll-Off, 96 kHz Sample Rate

Figure 7-31. Passband Magnitude

Figure 7-32. Stopband Magnitude

Figure 7-33. Impulse Response—Linear Phase

Figure 7-34. Impulse Response—Minimum Phase

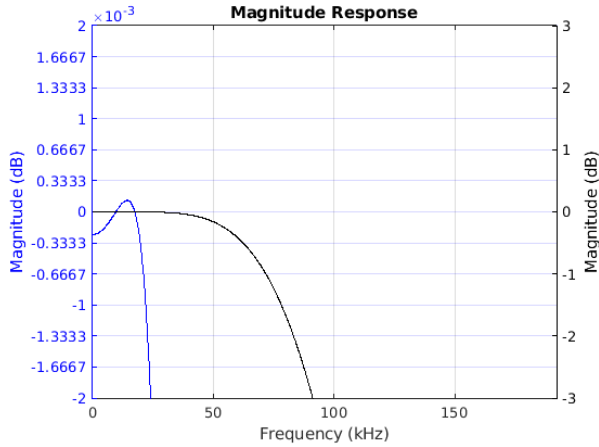
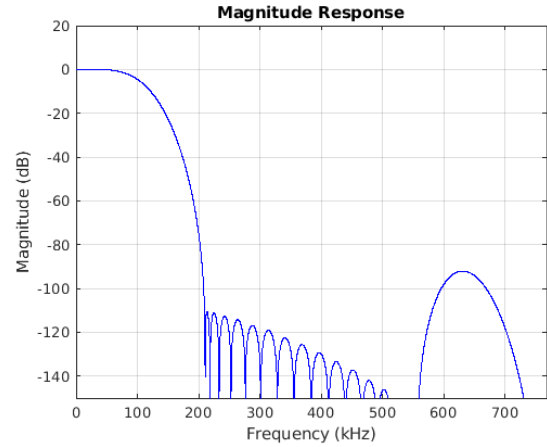
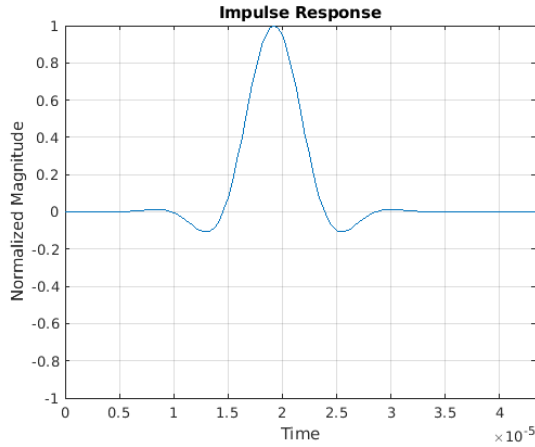
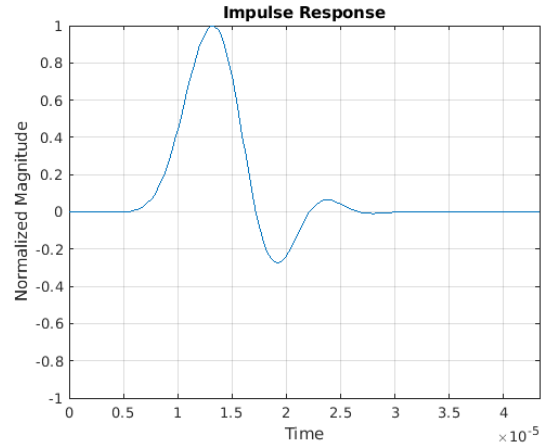
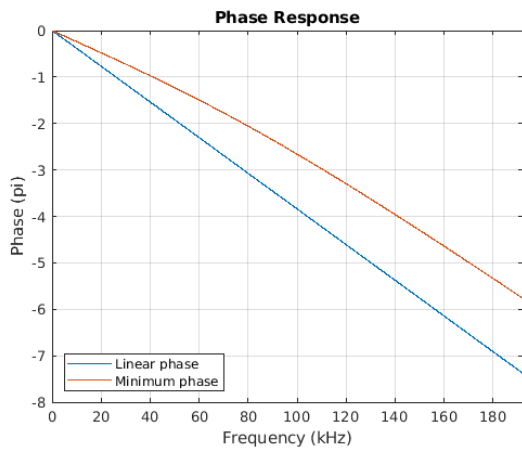
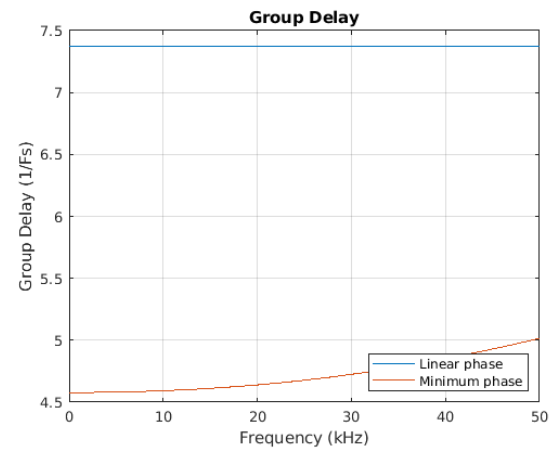
Figure 7-35. Phase vs. Frequency

Figure 7-36. Group Delay vs. Frequency

DAC Filter Response—Fast Roll-Off, 192 kHz Sample Rate

Figure 7-37. Passband Magnitude

Figure 7-38. Stopband Magnitude

Figure 7-39. Impulse Response—Linear Phase

Figure 7-40. Impulse Response—Minimum Phase

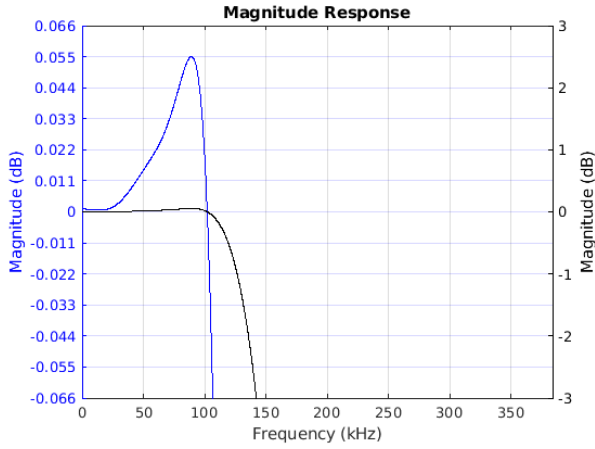
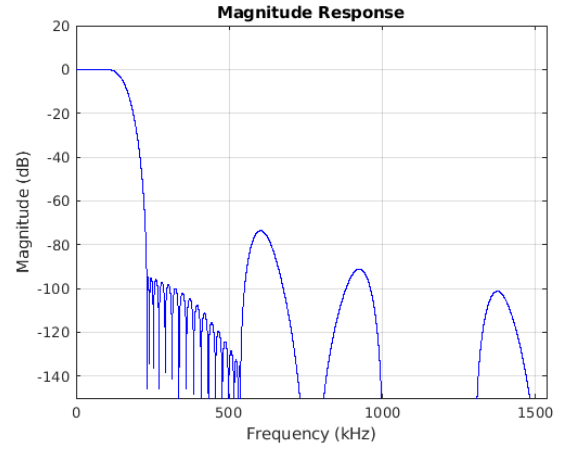
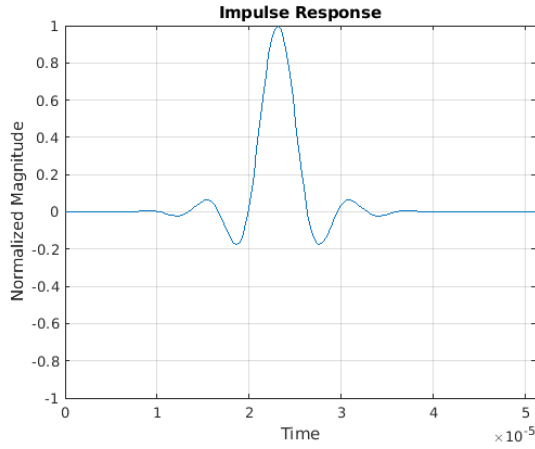
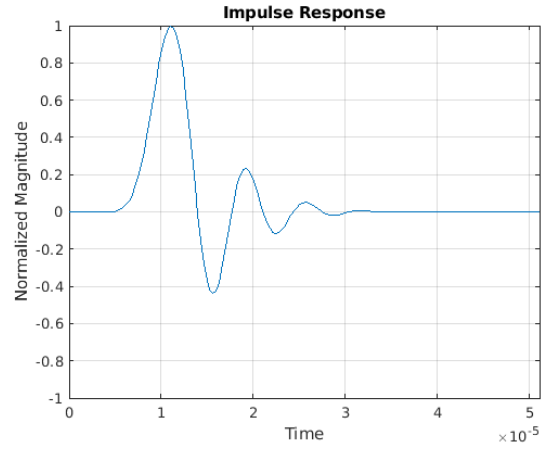
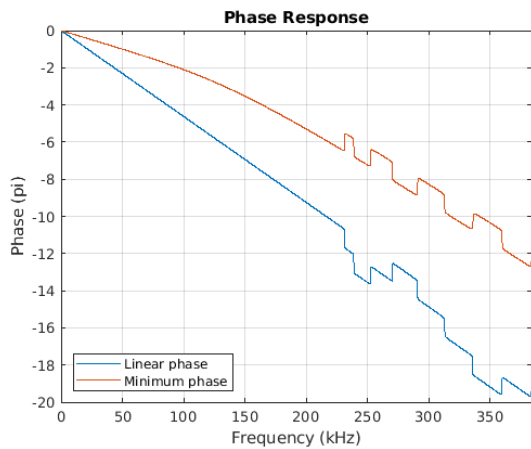
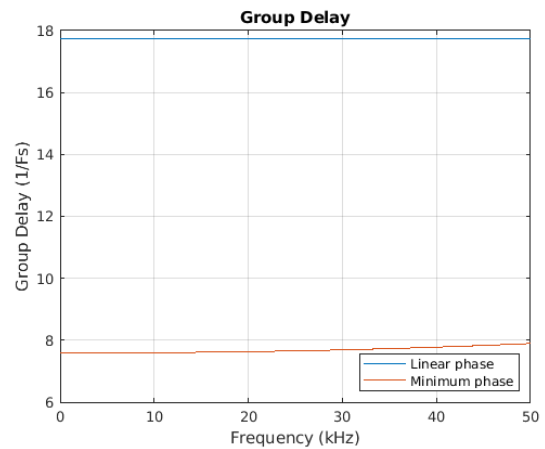
Figure 7-41. Phase vs. Frequency

Figure 7-42. Group Delay vs. Frequency

DAC Filter Response—Slow Roll-Off, 192 kHz Sample Rate

Figure 7-43. Passband Magnitude

Figure 7-44. Stopband Magnitude

Figure 7-45. Impulse Response—Linear Phase

Figure 7-46. Impulse Response—Minimum Phase

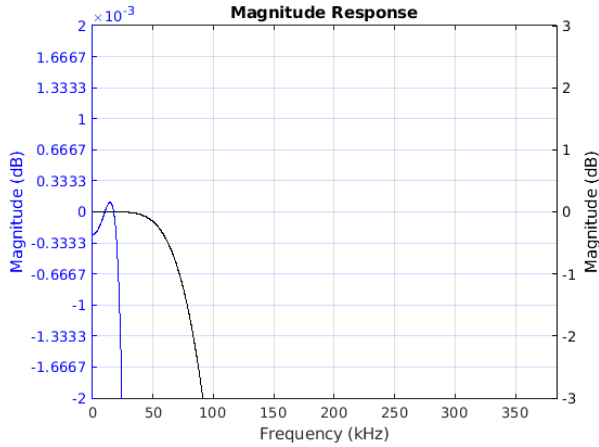
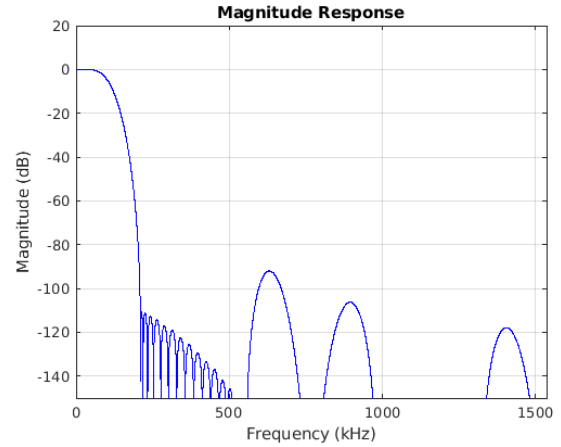
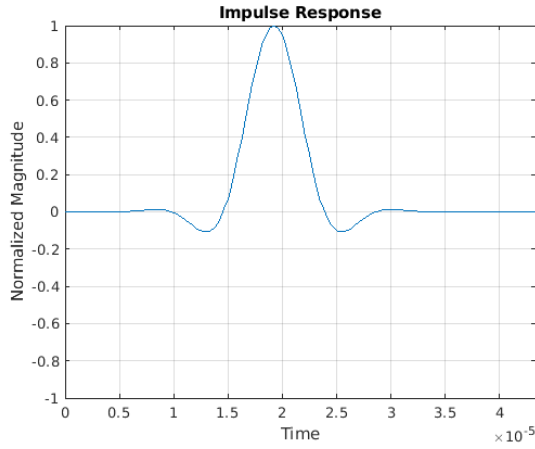
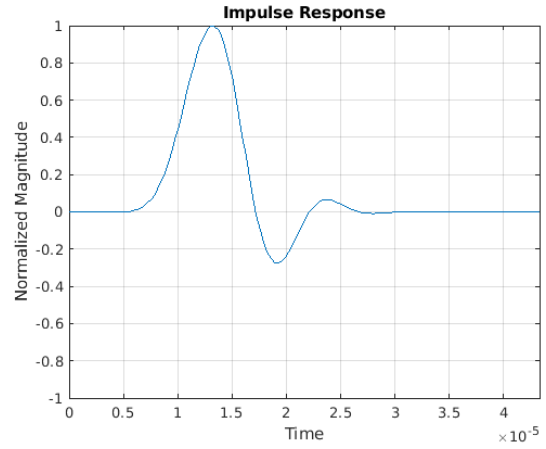
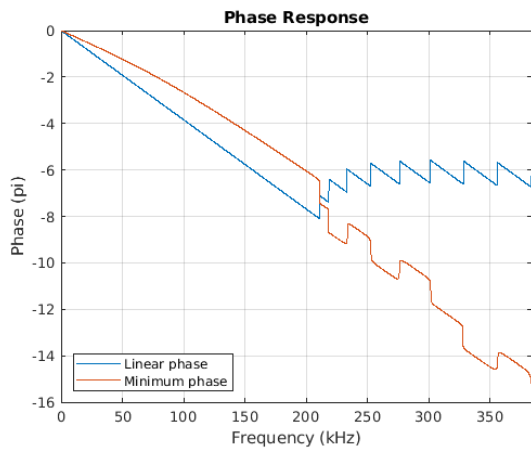
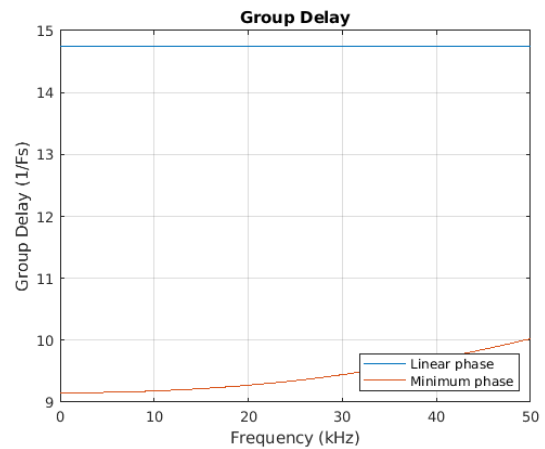
Figure 7-47. Phase vs. Frequency

Figure 7-48. Group Delay vs. Frequency

DAC Filter Response—Balanced Roll-Off, 192 kHz Sample Rate

Figure 7-49. Passband Magnitude

Figure 7-50. Stopband Magnitude

Figure 7-51. Impulse Response—Linear Phase

Figure 7-52. Impulse Response—Minimum Phase

Figure 7-53. Phase vs. Frequency

Figure 7-54. Group Delay vs. Frequency

DAC Filter Response—Fast Roll-Off, 384 kHz Sample Rate

Figure 7-55. Passband Magnitude

Figure 7-56. Stopband Magnitude

Figure 7-57. Impulse Response—Linear Phase

Figure 7-58. Impulse Response—Minimum Phase

Figure 7-59. Phase vs. Frequency

Figure 7-60. Group Delay vs. Frequency

DAC Filter Response—Balanced Roll-Off, 384 kHz Sample Rate

Figure 7-61. Passband Magnitude

Figure 7-62. Stopband Magnitude

Figure 7-63. Impulse Response—Linear Phase

Figure 7-64. Impulse Response—Minimum Phase

Figure 7-65. Phase vs. Frequency

Figure 7-66. Group Delay vs. Frequency

DAC Filter Response—Fast Roll-Off, 768 kHz Sample Rate

Figure 7-67. Passband Magnitude

Figure 7-68. Stopband Magnitude

Figure 7-69. Impulse Response—Linear Phase

Figure 7-70. Impulse Response—Minimum Phase

Figure 7-71. Phase vs. Frequency

Figure 7-72. Group Delay vs. Frequency

DAC Filter Response—Balanced Roll-Off, 768 kHz Sample Rate

Figure 7-73. Passband Magnitude

Figure 7-74. Stopband Magnitude

Figure 7-75. Impulse Response—Linear Phase

Figure 7-76. Impulse Response—Minimum Phase

Figure 7-77. Phase vs. Frequency

Figure 7-78. Group Delay vs. Frequency

8 Thermal Characteristics

Table 8-1. Typical JEDEC Four-Layer, 2s2p Board Thermal Characteristics

Parameter	Symbol	QFN	Units
Junction-to-ambient thermal resistance	θ_{JA}	18.69	$^{\circ}\text{C}/\text{W}$
Junction-to-board thermal resistance	θ_{JB}	5.51	$^{\circ}\text{C}/\text{W}$
Junction-to-case (top) thermal resistance	θ_{JC}	44.75	$^{\circ}\text{C}/\text{W}$
Junction-to-board thermal-characterization parameter	Ψ_{JB}	5.29	$^{\circ}\text{C}/\text{W}$
Junction-to-package-top thermal-characterization parameter	Ψ_{JT}	1.26	$^{\circ}\text{C}/\text{W}$

Notes:

- Natural convection at the maximum recommended operating temperature T_A (see Table 3-2)
- Four-layer, 2s2p PCB as specified by JESD51-9 and JESD51-11; dimensions: 101.5 x 114.5 x 1.6 mm
- Thermal parameters as defined by JESD51-12

9 Package Dimensions

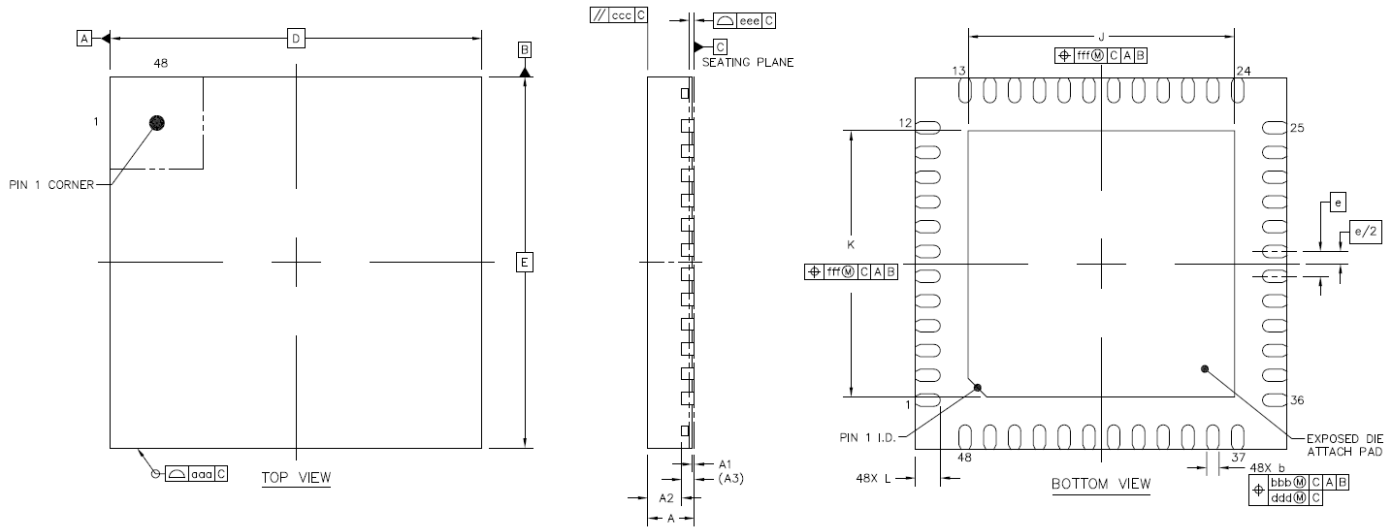

	SYMBOL	MIN	NOM	MAX	
TOTAL THICKNESS	A	0.7	0.75	0.8	
STAND OFF	A1	0	0.035	0.05	
MOLD THICKNESS	A2	---	0.55	---	
L/F THICKNESS	A3	0.203		REF	
LEAD WIDTH	b	0.15	0.2	0.25	
BODY SIZE	X	D	6	BSC	
	Y	E	6	BSC	
LEAD PITCH	e	0.4		BSC	
EP SIZE	X	J	4.2	4.3	4.4
	Y	K	4.2	4.3	4.4
LEAD LENGTH	L	0.3	0.4	0.5	
PACKAGE EDGE TOLERANCE	aaa		0.1		
LEAD OFFSET	bbb		0.1		
	ddd		0.05		
MOLD FLATNESS	ccc		0.1		
COPLANARITY	eee		0.08		
EXPOSED PAD OFFSET	fff		0.1		

Figure 9-1. QFN Package Drawing

10 Package Marking

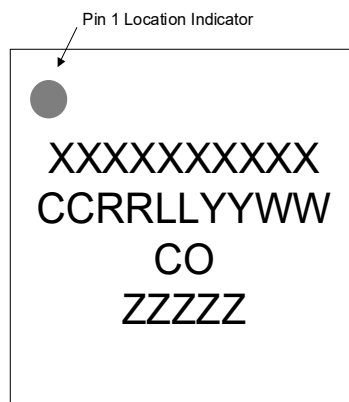
Top Side Brand

Line 1: Part number
 Line 2: Package mark
 Line 3: Country of origin (CO)
 Line 4: Encoded wafer/device ID

Package Mark Fields

CC = Cirrus Logic Index Code
 RR = Device revision code
 LL = Lot sequence code
 YY = Year of manufacture
 WW = Work week of manufacture

Figure 10-1. Package Marking

11 Ordering Information

Table 11-1. Ordering Information

Product	Description	Package	RoHS Compliant	Grade	Temperature Range	Container	Orderable Part Number
CS4308P	High Performance Multichannel Audio DAC	48-pin QFN	Yes	Commercial	-40 to +85°C	Tray	CS4308P-DN
CS4308P	High Performance Multichannel Audio DAC	48-pin QFN	Yes	Commercial	-40 to +85°C	Tape and Reel	CS4308P-DNR

12 References

- NXP Semiconductors, UM10204 Rev. 7, October 2021, *I2C-Bus Specification and User Manual*, <http://www.nxp.com>

13 Revision History

Table 13-1. Revision History

Revision	Changes
A1 NOV 2023	<ul style="list-style-type: none"> Initial version
A2 JUN 2024	<ul style="list-style-type: none"> Updated VDD_D reset thresholds (Table 3-9) Updated “fsb” references to “fs(base)” (Section 4.2, Section 4.4.1)
A3 DEC 2024	<ul style="list-style-type: none"> Recommended external components updated (Section 2, Section 4.5.4) ASP_DIN setup specification updated (Table 3-11) Thermal characteristics added (Section 8) Orderable part numbers updated (Section 11)

Important: Please check www.cirrus.com or with your Cirrus Logic sales representative to confirm that you are using the latest revision of this document and to determine whether there are errata associated with this device.

Contacting Cirrus Logic Support

For all product questions and inquiries, contact a Cirrus Logic Sales Representative.

To find one nearest you, go to www.cirrus.com.

IMPORTANT NOTICE

"Advance" product information describes products that are in development and subject to substantial development changes. For the purposes of our terms and conditions of sale, "Preliminary" or "Advanced" datasheets are nonfinal datasheets that include, but are not limited to, datasheets marked as "Target", "Advance", "Product Preview", "Preliminary Technical Data" and/or "Preproduction." Products provided with any such datasheet are therefore subject to relevant terms and conditions associated with "Preliminary" or "Advanced" designations, as set out in our terms and conditions of sale, including but not limited to that Cirrus Logic expressly disclaims any warranties with respect to such products. The products and services of Cirrus Logic International (UK) Limited; Cirrus Logic, Inc.; and other companies in the Cirrus Logic group (collectively either "Cirrus Logic" or "Cirrus") are sold subject to Cirrus Logic's terms and conditions of sale supplied at the time of order acknowledgment, including those pertaining to warranty, indemnification, and limitation of liability. Software is provided pursuant to applicable license terms. Cirrus Logic reserves the right to make changes to its products and specifications or to discontinue any product or service. Customers should therefore obtain the latest version of relevant information from Cirrus Logic to verify that the information is current and complete. Testing and other quality control techniques are utilized to the extent Cirrus Logic deems necessary. Specific testing of all parameters of each device is not necessarily performed. In order to minimize risks associated with customer applications, the customer must use adequate design and operating safeguards to minimize inherent or procedural hazards. Cirrus Logic is not liable for applications assistance or customer product design. The customer is solely responsible for its overall product design, end-use applications, and system security, including the specific manner in which it uses Cirrus Logic components. Certain uses or product designs may require an intellectual property license from a third party. Features and operations described herein are for illustrative purposes only and do not constitute a suggestion or instruction to adopt a particular product design or a particular mode of operation for a Cirrus Logic component.

CIRRUS LOGIC PRODUCTS ARE NOT DESIGNED, TESTED, INTENDED OR WARRANTED FOR USE (1) WITH OR IN IMPLANTABLE PRODUCTS OR FDA/ MHRA CLASS III (OR EQUIVALENT CLASSIFICATION) MEDICAL DEVICES, OR (2) IN ANY PRODUCTS, APPLICATIONS OR SYSTEMS, INCLUDING WITHOUT LIMITATION LIFE-CRITICAL MEDICAL EQUIPMENT OR SAFETY OR SECURITY EQUIPMENT, WHERE MALFUNCTION OF THE PRODUCT COULD CAUSE PERSONAL INJURY, DEATH, SEVERE PROPERTY DAMAGE OR SEVERE ENVIRONMENTAL HARM. INCLUSION OF CIRRUS LOGIC PRODUCTS IN SUCH APPLICATIONS IS UNDERSTOOD TO BE FULLY AT THE CUSTOMER'S RISK AND CIRRUS LOGIC DISCLAIMS AND MAKES NO WARRANTY, EXPRESS, STATUTORY OR IMPLIED, INCLUDING THE IMPLIED WARRANTIES OF MERCHANTABILITY AND FITNESS FOR PARTICULAR PURPOSE, WITH REGARD TO ANY CIRRUS LOGIC PRODUCT THAT IS USED IN SUCH A MANNER. IF THE CUSTOMER OR CUSTOMER'S CUSTOMER USES OR PERMITS THE USE OF CIRRUS LOGIC PRODUCTS IN SUCH A MANNER, CUSTOMER AGREES, BY SUCH USE, TO FULLY INDEMNIFY CIRRUS LOGIC, ITS OFFICERS, DIRECTORS, EMPLOYEES, DISTRIBUTORS AND OTHER AGENTS FROM ANY AND ALL LIABILITY, INCLUDING ATTORNEYS' FEES AND COSTS, THAT MAY RESULT FROM OR ARISE IN CONNECTION WITH THESE USES.

This document is the property of Cirrus Logic, and you may not use this document in connection with any legal analysis concerning Cirrus Logic products described herein. No license to any technology or intellectual property right of Cirrus Logic or any third party is granted herein, including but not limited to any patent right, copyright, mask work right, or other intellectual property rights. Any provision or publication of any third party's products or services does not constitute Cirrus Logic's approval, license, warranty or endorsement thereof. Cirrus Logic gives consent for copies to be made of the information contained herein only for use within your organization with respect to Cirrus Logic integrated circuits or other products of Cirrus Logic, and only if the reproduction is without alteration and is accompanied by all associated copyright, proprietary and other notices and conditions (including this notice). This consent does not extend to other copying such as copying for general distribution, advertising or promotional purposes, or for creating any work for resale. This document and its information is provided "AS IS" without warranty of any kind (express or implied). All statutory warranties and conditions are excluded to the fullest extent possible. No responsibility is assumed by Cirrus Logic for the use of information herein, including use of this information as the basis for manufacture or sale of any items, or for infringement of patents or other rights of third parties. Cirrus Logic, Cirrus, the Cirrus Logic logo design, and SoundClear are among the trademarks of Cirrus Logic. Other brand and product names may be trademarks or service marks of their respective owners.

Copyright © 2023–2024 Cirrus Logic, Inc. and Cirrus Logic International Semiconductor Ltd. All rights reserved.

SPI is a trademark of Motorola.